



**TTR500 Series
Vector Network Analyzer
Printable Help**





TTR500 Series
Vector Network Analyzer
Printable Help

Copyright © Tektronix. All rights reserved. Licensed software products are owned by Tektronix or its subsidiaries or suppliers, and are protected by national copyright laws and international treaty provisions.

Tektronix products are covered by U.S. and foreign patents, issued and pending. Information in this publication supersedes that in all previously published material. Specifications and price change privileges reserved.

TEKTRONIX and TEK are registered trademarks of Tektronix, Inc.

VectorVu-PC is a trademark of Tektronix, Inc.

Supports software v1.0

March 2017

Contacting Tektronix

Tektronix, Inc.
14150 SW Karl Braun Drive
P.O. Box 500
Beaverton, OR 97077
USA

For product information, sales, service, and technical support:

- In North America, call 1-800-833-9200.
- Worldwide, visit www.tek.com to find contacts in your area.

Table of Contents

Introduction

Introduction to TTR500 series VNAs	1
--	---

Product documentation

TTR500 series product documentation.....	3
--	---

Get started with the VNA

Understand the VNA	5
The front panel.....	5
The rear panel.....	7
System requirements	7
Power source specifications	7
Install VectorVu-PC	8
Set up TekVISA.....	8
VectorVu-PC vector analysis software	9
Screen area	10
Menu bar.....	10
Data entry bar	12
Soft key panel.....	12
Instrument status bar	13
Channel status bar	15
Graph area	16
Display update	17
Invert color	17

Set up the VNA

Set channels	19
Channel operations	19
Set traces.....	20
Set graph display	20
Multiple channels.....	20
Multiple traces	21
Characteristic impedance (system Z_0).....	21
Set stimulus conditions	21
Stimulus operations.....	21
Avoid spurious function.....	23
Set measurement parameters	23
S-parameters.....	23

Set S-parameters	24
Set absolute measurements	24
Set the bias tee	25
Select a data format	26
Rectangular format	26
Polar format	26
Smith chart format	27
Set the scale	28
Auto scale	29
Manual scale	29
Set a reference line value	30
Set window displays	30

Calibration

What is calibration?	31
Drift errors	31
Random errors	31
Systematic errors	31
Calibration workflow	32
The calibration plane	33
Definitions	34
Select a calibration kit	34
Select a calibration method	35
Calibrate the VNA	37
Isolation calibration	37
Response calibration (Short/Open) - Reflection Test	37
Response calibration (Thru) - Transmission Test	38
2-port 1-path SOLT (Enhanced Response) calibration	40
1-port SOL calibration (Reflection Test)	42
2-port 2-path SOLT (Full Two Port) calibration	43
Apply error correction	44
Enable error correction	44
Distinction from factory error correction function	45
Apply port extensions	45
Loss calculation	47
Partial overwrite	48

Additional calibration options

Manage calibration kits	49
Add/Modify a calibration kit	49
Define a calibration standard	49
Specify a subclass	50

Additional calibration kit operations	51
Calibration trigger source	51
Power calibration	51
Power calibration workflow	52
Requirements	52
Procedure	53
Receiver calibration	54
Procedure	54
Unknown thru calibration	55

Triggers and measurements

Set trigger for measurement	57
Sweep order in each channel	57
Set a trigger source	57
Set a trigger mode	58
Set the trigger scope	59
Additional trigger options	59
Point trigger	59
External trigger delay	59
Averaging	60
Averaging and triggers	60
Averaging with point trigger	60
Averaging trigger function	60
Sweep time calculation	61
Continuous sweep	61
Trigger sweep	62

Analyze data

Use markers on a trace	63
Set up marker display	63
Marker display format	64
Select a display mode	65
Relative value display (Delta mode)	66
Couple/Decouple markers	66
Marker search operations	66
Set search range	67
Maximum and minimum values	67
Search tracking	67
Target search	68
Peak search	69
Bandwidth search	69
Notch search for bandwidth	71

Trace data math operations	72
Normalize data	73
Save and display data	
Save VNA state	74
Save and recall trace/channel	74
Recall saved data	74
Limitations when recalling data	75
Save touchstone (SnP) files	75
S1P files	76
S2P files	76
Optimize measurements	
Expand dynamic range	77
Narrow the IF bandwidth	77
Enable sweep averaging	77
Improve phase measurement accuracy	78
Electrical delay	78
Phase offset	79
Improve measurement throughput	80
Switch off information update	80
Disable factory error correction	80

System options

System option group	81
Save/Recall	81
Preset	82
Language	82
More options	83
Connections	83
Use Connection Manager	84
Simulator	85
Load SnP	85
Noise Floor	85
Log severity and OPC logger	86

Default settings

Stimulus options	87
Channel/Trace options	88
Response options	89
Markers/Analysis options	91
System options	92

Measurement Examples

Frequency response of a band pass filter	93
Calibrate the VNA	93
Set up the band pass filter	93
Record S-parameters	94
Bandwidth search	95
Use touchstone (SnP) files for offline analysis	96
Save an S2P file	97
Recall an S2P file	97

Product information

How the VNA operates	99
Directional coupler	100
Synthesized RF sources	100
Receivers	100
Controls/Communication logic	100
Time base	100
USB	101
Power supply	101
Synchronization and trigger	101
Bias tee	101
Device information	101
Software download	103
Environmental specifications	103
Log data	103
Recommended calibration kits	104
Measurement accessories	105
Attenuators and bias tee	105
Cables	105
Adapters and test cables	106
Accessory cables	107
Calibration kits	107

Standard Functions

Standard Functions	109
--------------------------	-----

Maintain your VNA

Maintain your VNA	111
Clean the VNA	111
Return the VNA	111

Troubleshoot your VNA

Troubleshoot the VNA	113
IEEE error messages	113
VNA error messages	115
Warnings and notifications	118

Index

Introduction to TTR500 series VNAs

The TTR500 series (503A/506A) Vector Network Analyzer (VNA) is a portable, 2-port network analyzer. The VNA operates over a frequency range of 100 kHz-3 GHz (TTR503A) and 100 kHz-6 GHz (TTR506A). You use the VNA to measure the network parameters of electrical networks to characterize high-frequency passive components and active devices (in their linear mode of operation). The VNA separates signal sourcing and detection from processing measurements, which you perform using the VectorVu-PC vector network analysis software. VectorVu-PC software is available in the TTR500 series instrument. When you connect the VNA to a PC for the first time, VectorVu-PC installs on the computer.

You use an AC adapter to power the analyzer. The VNA connects to a Windows PC through a standard USB 2.0 cable. You can also sync the VNA with other instruments using an external trigger.



See Also

- [Install VectorVu-PC](#)

TTR500 series product documentation

In addition to the compiled help file, these manuals are available in the TTR500 series product documentation set:

- Quick Start Guide containing installation, safety, and compliance instructions
- Programmer's reference
- Specifications and performance verification
- Security and declassification

You can download all of these manuals at www.tek.com/downloads.

Understand the VNA

You use the VNA to make network parameter measurements. You analyze these measurements using VectorVu-PC software on a Windows machine. VectorVu-PC is preloaded on the instrument. When you first connect the VNA to a Windows PC, VectorVu-PC installs on the machine. Use VectorVu-PC to process measurement data captured using the TTR500 series VNAs or view data obtained using other VNAs.

These topics describe the hardware and software interfaces of the TTR500 series VNA.

Topic	Related information
Hardware	■ The front panel
	■ The rear panel
Requirements	■ System requirements
	■ Power source requirements
Software installation	■ Install VectorVu-PC
Software	■ VectorVu-PC vector analysis software
	■ Screen area
	■ Menu bar
	■ Data entry bar
	■ Soft key panel
	■ Instrument status bar
	■ Channel status bar
■ Graph area	

The front panel

The front panel of the TTR503A and TTR506A VNAs has these components:

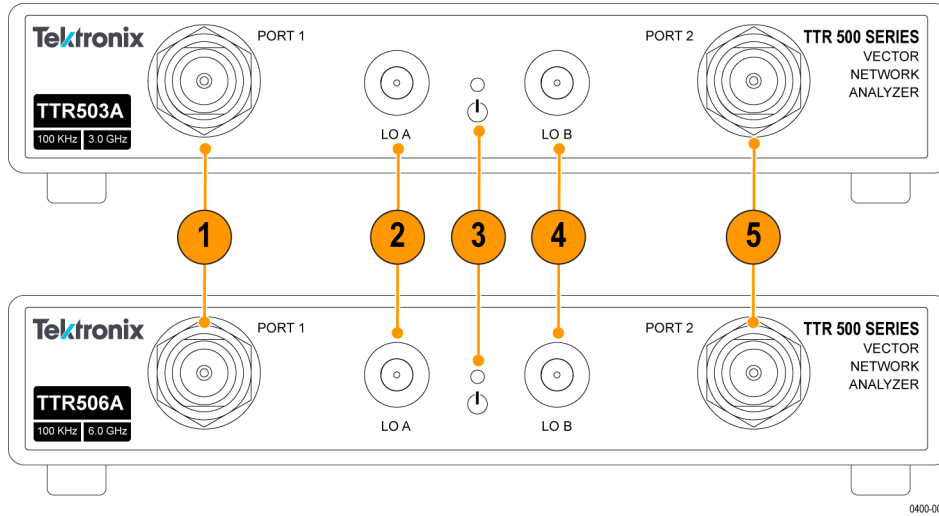

No.	Component	Description
1	RF Port 1	N-type 50 Ω female test port for device-under-test (DUT) connection. Use either RF port for stimulus source or response receiver. Maximum operational RF input level 10 dBm (100 kHz–6 GHz)
2	LO A	SMA 50 Ω female port 10 dBm, 0 VDC (reserved for future use)
3	LED Indicator	Indicates whether the VNA is powered and disconnected (red) or connected (green).
4	LO B	SMA 50 Ω female port 10 dBm, 0 VDC (reserved for future use)
5	RF Port 2	N-type 50 Ω female test port for device-under-test (DUT) connection. Use either RF port for stimulus source or response receiver. Maximum operational RF input level 10 dBm (100 kHz–6 GHz)

The rear panel

The rear panel of the TTR503A and TTR506A VNAs has these components:

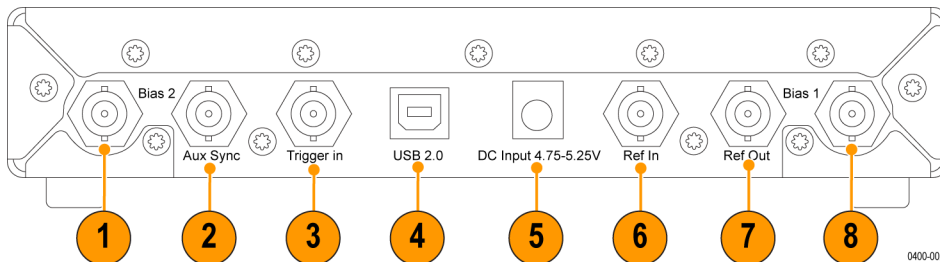

No.	Component	Description
1	Bias 2	Provides bias input for RF port 2
2	Aux Sync	50 Ω female BNC connector (reserved for future use)
3	Trigger In	50 Ω female BNC connector to connect an external device to provide a trigger input
4	USB 2.0	Connect USB 2.0 cable to Windows PC
5	4.75 V– 5.25 VDC	DC input to power the instrument
6	Ref In	50 Ω female BNC high impedance connector to provide optional 10 MHz reference input
7	Ref Out	50 Ω female BNC connector to provide 10 MHz reference output
8	Bias 1	Provides bias input for RF port 1

System requirements

Each TTR500 series VNA instrument connects to a Windows PC machine and requires 1 USB port.

The VectorVu-PC software operates on Windows 7/8/10 operating systems.

Power source specifications

Characteristic	Description
AC input voltage	100 VAC – 240 VAC 47 Hz – 63 Hz
DC power output	4.75 V – 5.25 V
VNA power consumption	<16 W

Install VectorVu-PC

From the VNA

1. Connect the VNA to a power source using the AC adapter.
2. Use the USB 2.0 cable to connect the VNA to your Windows PC.
3. In Windows, navigate to the TTR500 drive and run **setup.exe**. The installation wizard opens.
4. Follow the steps in the installation wizard to install VectorVu-PC and Tektronix TTR500 family driver files. Optionally, you can also install the TekVISA program to communicate with VectorVu-PC through a programmatic interface.

NOTE. *If you need to perform power calibration to measure active devices, install Tektronix Power Meter Apps V4_5 to use the Tektronix PSM Series Power Meters. For other supported power meters and power sensors, see [Power calibration requirements](#).*

From the web

You can download VectorVu-PC from the Tektronix website at www.tek.com/downloads.

Set up TekVISA

When you install VectorVu-PC, you can also choose to install the TekVISA application package. TekVISA is the Tektronix implementation of VISA (Virtual Instrument Software Architecture), an industry-standard communication protocol.

When installed on a PC, TekVISA provides communication with instruments that are connected to the PC using the OpenChoice Instrument Manager application. You can also communicate with the VNA through a programmatic interface using the OpenChoice Talker Listener program in the TekVISA package.

NOTE. *If you have a previous version of TekVISA already installed on your system, this may not be compatible with the TTR500 series VNA. To ensure proper functionality, install TekVISA through the VectorVu-PC installation wizard.*

Programmatic operation

Once you have installed VectorVu-PC and TekVISA programs using the installation wizard,

1. Open the OpenChoice Instrument Manager application.
2. Click **Identify**. The Instrument Manager recognizes the TTR500 VNA. When you connect multiple VNAs to your computer, Instrument Manager detects all connected instruments.

3. Open the OpenChoice Talker Listener application. The VNA should appear in the Instrument window.
4. Enter *IDN? in the Command text box and click **Query**. The application identifies the VNA in the window below.

You can now send SCPI commands to communicate with the VNA. For more information on compatible SCPI commands and their syntaxes, refer to the *TTR500 Programmers Manual* available at www.tek.com.

Remote connection

You can use OpenChoice Talker Listener to login remotely from another machine and issue SCPI commands to the VNA. Use the Windows Remote Desktop option for this purpose.

VectorVu-PC vector analysis software

When you power the VNA and connect it to a Windows PC for the first time, the instrument prompts you to install VectorVu-PC – the vector network analysis software that you use to process measurements.

Use VectorVu-PC to make network parameter measurements of passive components and active devices. You can also use VectorVu-PC to view measurement data recorded in touchstone files (S1P, S2P formats) using other VNAs as well as data generated from circuit simulation software.

Screen area

The primary components of the VectorVu-PC interface are:

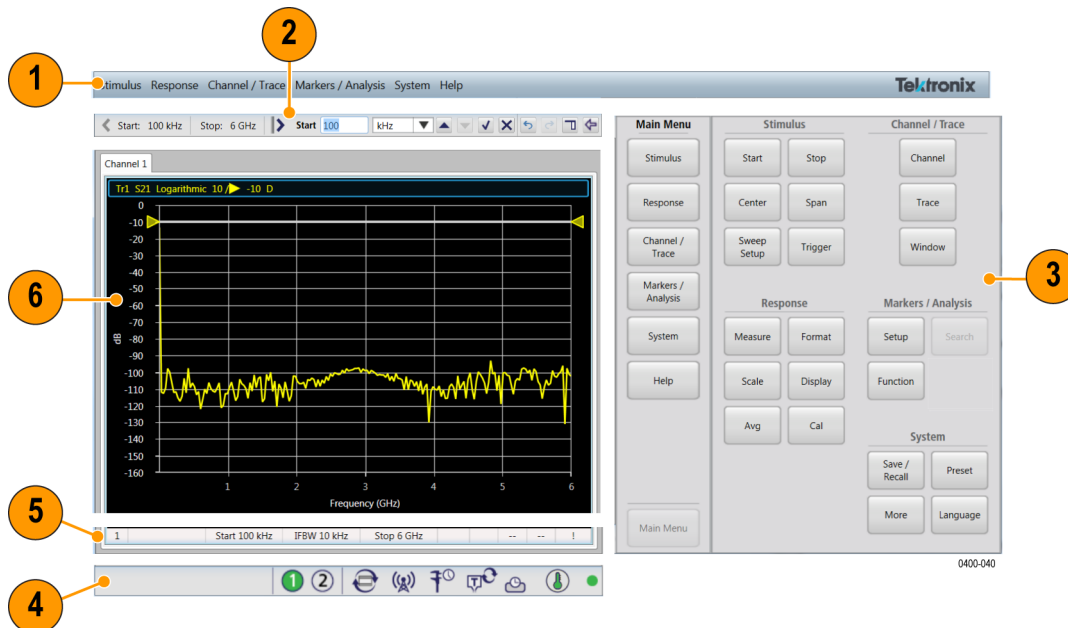

No.	Component
1	Menu bar
2	Data entry bar
3	Soft key panel
4	Instrument status bar
5	Channel status bar
6	Graph area

Menu bar

The menu bar has several groups of options available as pull-down menus. Each of the option groups has a corresponding set of soft keys in the soft key panel. You can access all of these menus using a mouse or touch screen.

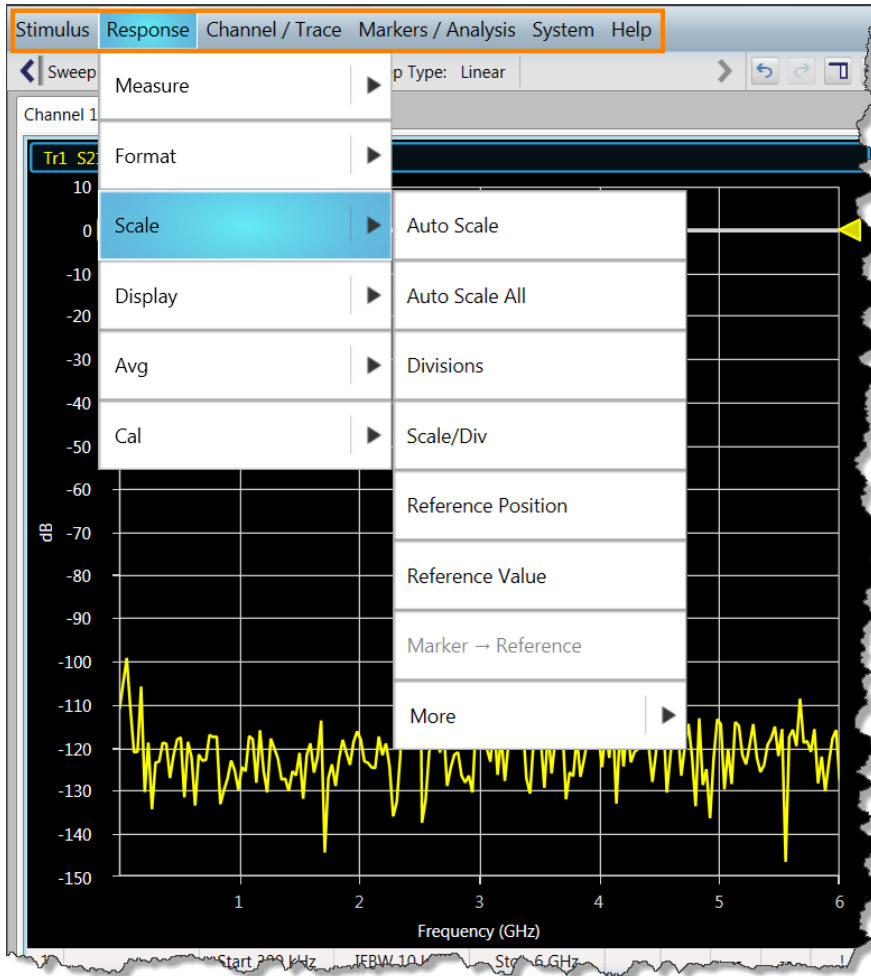

In the **Response** option group:

Action	Soft key
Show/hide the menu bar	Display > Menu Bar > Display Menu Bar
Set the font size for the menu bar	Display > Menu Bar > Bar Font

See Also

- [Data entry bar](#)

Data entry bar

The data entry bar displays values of parameters associated with the selected menu (or ‘active menu’).

Click on a parameter in the data entry bar to change its value. Click or press the enter key to apply the change. You also use the data entry bar when a setting in the active menu or submenu requires a data entry for a parameter.

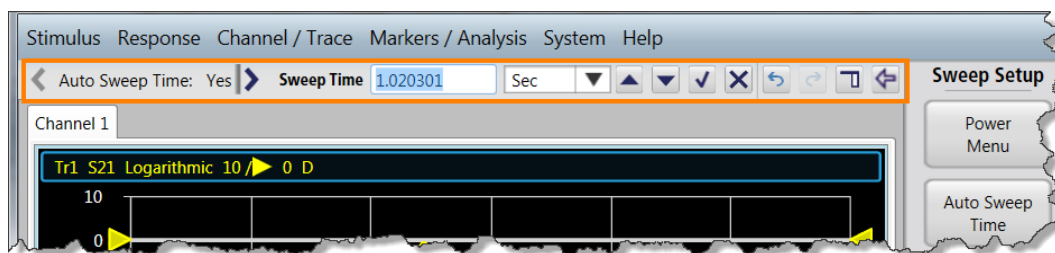

See Also

- [Soft key panel](#)

Soft key panel

The soft key panel contains option groups with different operations. Each of these option groups have pull-down menus in the menu bar. Some of the operations in an option group contain submenus for selections and data entry. You can access all of these menus using a mouse or touch screen.

Option Group	Description
Channel/Trace	Select the number and layout of channels and traces to display.
Markers/Analysis	Set markers, perform search analysis, and adjust graph parameters using markers.
Stimulus	Set frequency range, sweep, power, and trigger parameters.
Response	Measure system response for the stimulus through network parameters, calibrate the DUT, and set display options.
System	Select language options, manage device connections, save and recall states, or restore factory preset.

When you select an operation in an option group, any submenu it contains becomes the active menu. If there are no submenus, the entire option group is displayed.

For example, if you want to set up a sweep operation, select the **Sweep Setup** operation in the **Stimulus** option group. The **Sweep Setup** submenu becomes the active menu.

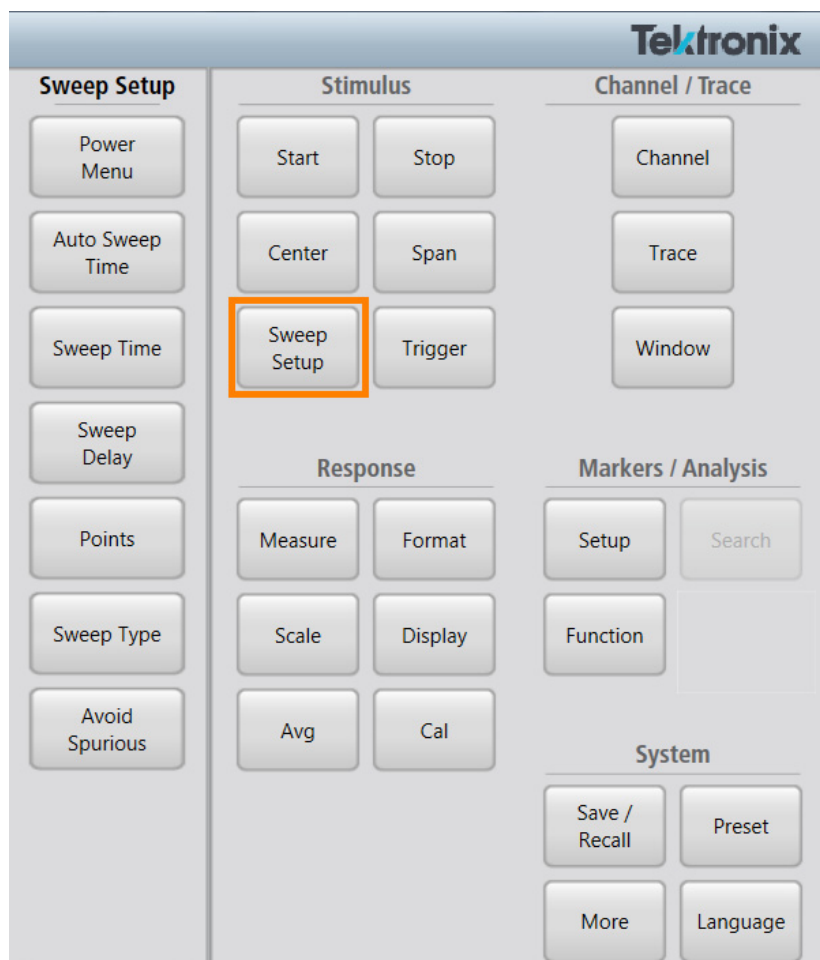

See Also

- [Instrument status bar](#)

Instrument status bar

The instrument status bar displays settings and usage information about your TTR500 VNA. Use the corresponding soft key paths to change these settings.

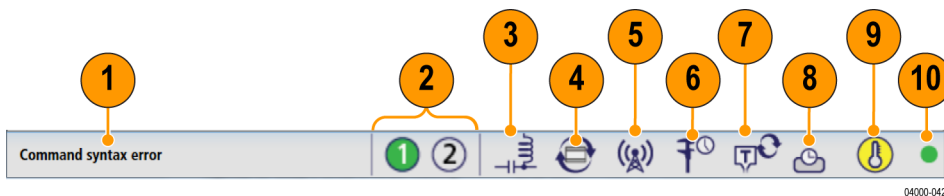

N-o.	Setting	Indication	Default	Soft key path
1	Error/warning messages	-	Not applicable	-
2	Active port	Active port that is currently transmitting.	Port 1 active (solid circle)	No soft key. Switch device or cable connection to port 2.
3	Bias tee setup	Display indicates that internal bias tee is enabled.	Off (does not display)	System > More > Bias tee
4	Display update.	Enable/disable dynamic updates to graph.	ON (Enable dynamic update)	Display > Update
5	RF Out.	Enable/disable RF output.	ON (Enable RF output)	Stimulus > Sweep Setup > Power Menu > RF Out
6	Measurement status	Measurement initialized or in progress.	In Progress	-
7	Trigger source	Trigger source used: <ul style="list-style-type: none"> ■ Internal ■ External ■ Manual ■ SCPI 	Internal	Stimulus > Trigger > More > Trigger Source
8	Reference clock source	Clock source used: <ul style="list-style-type: none"> ■ Internal ■ External 	Internal	System > More > Reference Clock Source

N- o.	Setting	Indication	Default	Soft key path
9	Temperature	Temperature setting of TTR500 instrument	<ul style="list-style-type: none"> ■ Yellow when starting VNA or stabilizing internal temperature ■ Green when VNA is in normal operation. ■ Red when instrument is overheated. VectorVu-PC switches to offline mode. 	-
10	Instrument Connection.	Information about active connection to VectorVu-PC—instrument paired with an instance of the program.	Green indicates an active VNA connection or simulator (offline) mode.	System > More > Connections

NOTE. When you operate VectorVu-PC in simulator (offline) mode, the instrument status bar turns gray with the exception of the Instrument Connection icon. Errors and warning messages are available when using the simulator. All other settings apply only when VectorVu-PC has an active connection with a TTR500 VNA.

See Also

- [Channel status bar](#)

Channel status bar

The channel status bar displays these parameters about the channel.

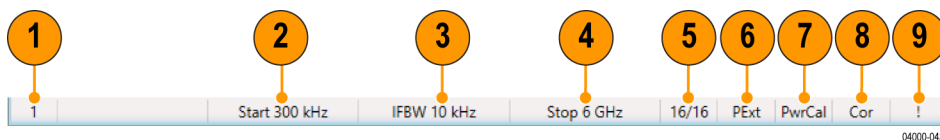

No.	Parameter	Description
1	Channel number	Number of the current channel
2	Start (or Center) frequency	Start (or Center) frequency of sweep
3	IF Bandwidth	IF bandwidth for the frequency sweep
4	Stop (or Span) frequency	Stop (or Span) frequency of sweep
5	Averaging status	Averaging count (n) / Averaging factor (m) ratio indicates averaging ON No display indicates averaging OFF
6	Port extension status	PExt indicates port extension ZExt indicates impedance extension No display indicates no extension set
7	Power calibration status	PC indicates power calibration ON. No display indicates no power calibration data
8	Error correction status	Cor indicates error correction ON Off indicates error correction turned OFF ! indicates error correction has different parameters * indicates error correction is interpolated
9	Channel measurement status	! indicates measurement in progress # indicates invalid traces, if they have not been updated to match a change in measurement conditions No display indicates the measurement has not been executed

See Also

- [Graph area](#)

Graph area

The graph area displays trace measurements on the DUT. If a channel has multiple traces, in the default setting, all traces of that channel appear on a single graph. You can display channels or traces individually by selecting:

- **Channel / Trace > Channel > Channel Layout**
- **Channel / Trace > Trace > Trace Layout**

Display update

By default, the graph updates trace information dynamically when you perform measurements. For improved speed of performance, you can turn off display update. Set or clear this feature in **Response > Display > Update**.



The status of this feature is visible in the  icon in the instrument status bar. When you disable display update, the data entry bar is not updated either.

Invert color

When you need to print an image of the graph area, invert the colors of the graph to reduce ink usage and improve clarity on paper. Select this option in **Response > Display > Invert Color**.

Set channels

A channel is a specific setup or configuration of the VNA to make a measurement. Channels operate like independent analyzers with these settings:

- Stimulus signal settings (frequency range, sweep type, etc.)
- IF bandwidth and averaging
- Calibration

Up to 16 channels are available to make measurements under different stimulus conditions using the VNA. Since all channels operate independent of each other, perform a calibration every time you set up a new channel for better accuracy.

Each allocated channel contains one trace by default. Additionally, you can add up to 16 traces for a channel.

NOTE. *Set channels and traces before setting up measurement conditions since some measurement parameters apply only to an active trace or channel.*

To set channels,

1. Select **Channel / Trace > Channel > Num Channels**.
2. Select the required number of channels in the data entry bar.

When you recall an instrument state that was previously saved, configurations with fewer channels are easier to load than configurations with a large number of channels. Therefore, states with 1 or 2 channels load much faster than states with 13–16 channels.

Channel operations

When you select multiple channels, the default display shows the active channel only. The active channel is the channel that is currently selected and whose settings can be changed. The active channel cannot display measurements made on another channel.

Operation	Soft key path
Set number of channels to display	Channel / Trace > Channel > Num Channels
Assign additional channel to display (up to 16 channels)	Channel / Trace > Channel > Allocate Channel
Set graph layout to display assigned channels	Channel / Trace > Channel > Channel Layout
Maximize active channel	Channel / Trace > Channel > Max
Set the active channel	Channel / Trace > Channel > Active

Operation	Soft key path
Select the previous channel	Channel / Trace > Channel > Previous
Select the next channel	Channel / Trace > Channel > Next

You can assign the same channel across multiple display windows.

You can also use triggers to perform measurements on a channel without making it active.

See Also:

- [Set Trigger for Measurement](#)

Set traces

The trace display sets the number of traces to be displayed in a single channel.

Operation	Soft key path
Set number of traces to display in the active channel	Channel / Trace > Trace > Num Traces
Assign a trace to a particular channel	Channel / Trace > Trace > Allocate Trace
Set graph layout to display assigned traces	Channel / Trace > Trace > Trace Layout
Maximize a trace	Channel / Trace > Trace > Max
Move a trace (between windows of the same channel only)	Drag and drop the trace.
Set the active trace	Channel / Trace > Trace > Active
Select the previous trace	Channel / Trace > Trace > Previous
Select the next trace	Channel / Trace > Trace > Next

Set graph display

Multiple channels

When you select multiple channels, each channel is assigned to a window. By default, you see the graph of the active channel. When you use the **Previous** and **Next** soft keys, you can switch between channels to see the traces they contain.

To view the graphs of multiple or all channels simultaneously, change the display configuration:

- In **Channel / Trace > Channel > Channel Layout**.
- In **Channel / Trace > Window > Graph Layout > Channel Layout**.

Multiple traces

When you select multiple traces for a channel, all viewable traces display on the active channel in different colors. To view each trace in a separate window, change the display configuration in **Channel / Trace > Trace > Trace Layout**.

Characteristic impedance (system Z_0)

The characteristic impedance of a TTR500 series VNA is fixed at 50 Ω .

Set stimulus conditions

Use settings in the **Stimulus** option group to define these stimulus parameters to provide to the DUT.

- Start frequency
- Stop frequency
- Center frequency
- Span frequency
- Sweep parameters
- [Trigger parameters](#)

Stimulus operations

Sweep frequency

Setting	Options/Description	Soft key
Sweep range	Start/Stop define a sweep between starting and stopping frequencies	<ul style="list-style-type: none"> ■ Stimulus > Start ■ Stimulus > Stop
	Center/Span define a sweep based on a frequency span around a center frequency	<ul style="list-style-type: none"> ■ Stimulus > Center ■ Stimulus > Span

Sweep setup

Setting	Options/Description	Soft key
Auto sweep time	VectorVu-PC automatically configures sweep time setting.	Sweep Setup > Auto Sweep Time
Sweep time	Time taken to complete a sweep (excludes sweep delay). Use sweep time to control measurement time.	Sweep Setup > Sweep Time
Sweep delay	Delay before starting a sweep for a measurement to account for device stabilization	Sweep Setup > Sweep Delay
Points (Number of measurement points)	Set 1–20,001 points to measure in a single sweep for each channel	Sweep Setup > Points
Sweep type	<ul style="list-style-type: none"> ■ Lin Freq – sweeps frequencies in linear scale ■ Log Freq – sweeps frequencies in logarithmic scale 	Sweep Setup > Sweep Type
Measure in time-series (Time sweep)	Time the sweep operation and display measurement parameter versus time.	Set Span to 0.
Avoid spurious	Remove unwanted signals from measurement display.	Sweep Setup > Avoid Spurious See also Avoid spurious function .

Power menu

Setting	Options/Description	Soft key
Power level	<ul style="list-style-type: none"> ■ Power Level – Sets power level of the stimulus signal in dBm. Set the same power level across all ports when coupled ■ Port Power – Set individual power levels for every port in dBm when ports are decoupled 	<ul style="list-style-type: none"> ■ Sweep Setup > Power Menu > Port Couple > Yes to couple ports. ■ Sweep Setup > Power Menu > Power Level ■ Sweep Setup > Power Menu > Port Couple > No to decouple ports. ■ Sweep Setup > Power Menu > Port Power
Slope	Compensate for power losses in cables and test fixtures at high frequencies	Sweep Setup > Power Menu > Slope
Slope Value	Specify a value in dB/GHz for power slope when slope is enabled.	Sweep Setup > Power Menu > Slope Value
RF Out	<ul style="list-style-type: none"> ■ Yes – Enable stimulus signal output. In case of power trip, use this setting to turn output back ON. ■ No – Cannot perform measurements. 	Sweep Setup > Power Menu > RF Out

Trigger settings

Setting	Options/Description	Soft key
Trigger	Set source, delay, scope and other trigger settings.	Stimulus > Trigger See also Set trigger for measurement

Avoid spurious function

Spurious signals are unwanted signals that can generate in the VNA hardware due to interactions between internal signals (such as processor clocks and local oscillators). These signals can appear as narrow spikes (<10 kHz wide) at very low levels, near the receiver noise floor at IF bandwidths that are smaller than 1 kHz.

The **Avoid Spurious** function (**Stimulus > Sweep Setup**) removes these responses from the measurement display. This function is enabled by default.

Narrow band devices

When you measure very narrow band devices such as crystal filters, the passband of the filter can coincide with the spurious response. In these cases, disable the spur avoidance function by toggling the **Avoid Spurious** function off.

Set measurement parameters

You use the VNA to characterize a device or component using scattering parameters or S-parameters. These sections discuss:

- [S-parameters](#)
- [How to set S-parameter measurements](#)
- [How to set absolute measurements](#)

S-parameters

For a device network that operates at high frequencies (~ MHz/GHz), circuit dimensions are typically much larger than the wavelength of the current. Characterizing such a device is easier using forward and reverse traveling waves instead of voltage or current measurements. The ratios of these traveling waves are represented by scattering parameters or S-parameters.

For a two-port network with characteristic impedances Z_{01} and Z_{02} , the forward traveling wave enters the network as a_1 at port 1 and exits as b_2 at port 2. The reverse wave enters the network as a_2 at port 2 and exits as b_1 at port 1.

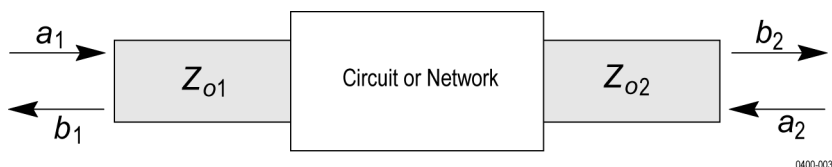

a_1 and a_2 then become the incident waves while b_1 and b_2 are the reflected waves.

S-parameters are the ratios of measurements of incident and reflected waves.

$$b_1 = S_{11}a_1 + S_{12}a_2$$

$$b_2 = S_{21}a_1 + S_{22}a_2$$

For example, S_{21} is the ratio of the signal exiting at port 2 to the signal entering at port 1. This table describes the S-parameters for a 2-port network.

S-parameter	Ratio	Description
S_{11}	$\frac{b_1}{a_1}$	Port 1 reflection coefficient
S_{21}	$\frac{b_2}{a_1}$	Forward transmission coefficient (from port 1 to port 2)
S_{12}	$\frac{b_1}{a_2}$	Reverse transmission coefficient (from port 2 to port 1)
S_{22}	$\frac{b_2}{a_2}$	Port 2 reflection coefficient

Since S-parameters are vector quantities, they describe the magnitude and phase of the signal.

Set S-parameters

1. In the **Response** option group, click **Measure**.
2. Select the S-parameter you want to measure.

Set absolute measurements

Absolute measurements measure the absolute levels of signals at the input of the VNA receiver. While S-parameters involve a relation between input signals of two receivers, absolute measurements apply only to the input signal of one receiver. Therefore, absolute measurements are individual signals while S-parameters are ratios of test and reference signals.

Absolute measurement	Description
A1	Test signal at port 1 when stimulus is on port 1
A2	Test signal at port 2 when stimulus is on port 1
B1	Test signal at port 1 when stimulus is on port 2
B2	Test signal at port 2 when stimulus is on port 2
R11	Reference signal at port 1 when stimulus is on port 1

Absolute measurement	Description
R12	Reference signal at port 1 when stimulus is on port 2
R21	Reference signal at port 2 when stimulus is on port 1
R22	Reference signal at port 2 when stimulus is on port 2

To make an absolute measurement, click **Response > Measure > Absolute** and select the absolute measurement.

Set the bias tee

Measuring some active DUTs requires a DC voltage to be applied to the RF center conductor. You can feed this DC voltage at the bias tee inputs on the rear panel of the TTR500 VNA. The VNA supplies the DC voltage to the DUTs through the RF port via the inner conductor. This is very useful when measuring applications where a DC signal has to be applied to the RF port of a DUT.

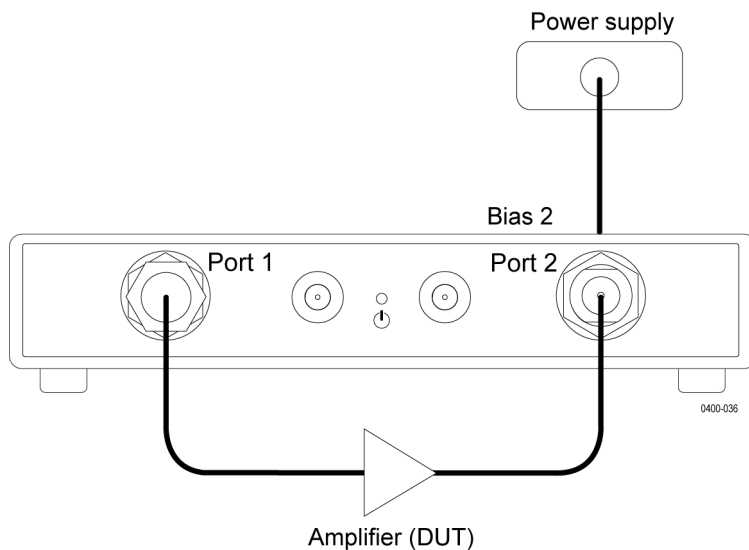

To use the internal bias tee,

1. Connect a power supply to the bias tee connectors in the rear panel for each port.
2. In **System > More > Bias Tee**, enable the bias tee function.

NOTE. Do not power the bias tee connectors during calibration to avoid damage to calibration standards.

Select a data format

In the **Response > Format**, select a data format to display your measurement data. These formats are available:

- Rectangular format
- Polar format
- Smith chart format

Rectangular format

In the rectangular format, you plot the measured response values on the Y-axis against stimulus values on the X-axis. Depending on the type of measured response value on the Y-axis, select from one of these formats:

Format	Label	Data Type	Measurement Unit
Log magnitude	Log Mag	Magnitude	dB
Phase	Phase (Deg)	Phase (degrees)	Degrees
	Phase (Rad)	Phase (radians)	Radians
	Group Delay	Time	Seconds
	Expanded Phase	Phase (degrees/radians)	Degrees/Radians
	Positive Phase	Phase (degrees/radians)	Degrees/Radians
Linear magnitude	Lin Mag	Magnitude	No dimension
Standing Wave Ratio	SWR	-	No dimension

Polar format

When you represent complex numbers in the polar format, the magnitude of the number is the displacement from a reference point while the phase becomes the counter-clockwise angular displacement from a reference direction. You indicate the frequency using markers since the polar format does not have a frequency axis.

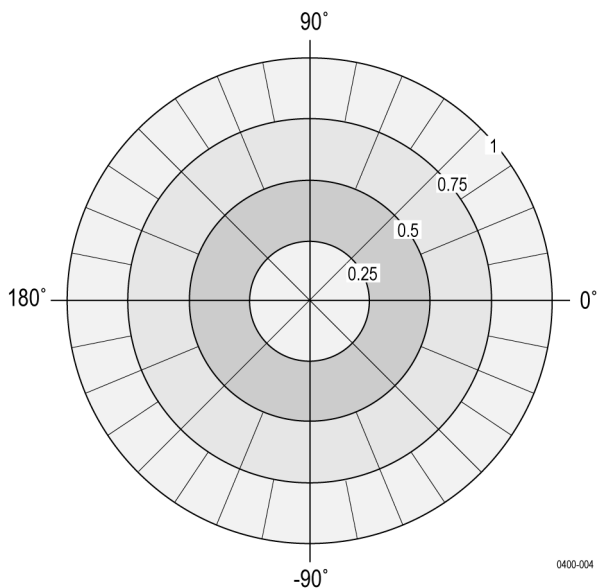

Use the polar format to display these data groups:

- Linear magnitude and phase
- Logarithmic magnitude and phase
- Real and imaginary parts

Smith chart format

The Smith chart maps reflection coefficients of measurement data from the DUT to normalized impedances. You plot traces using the same information as in the polar format. Frequencies are indicated by markers.

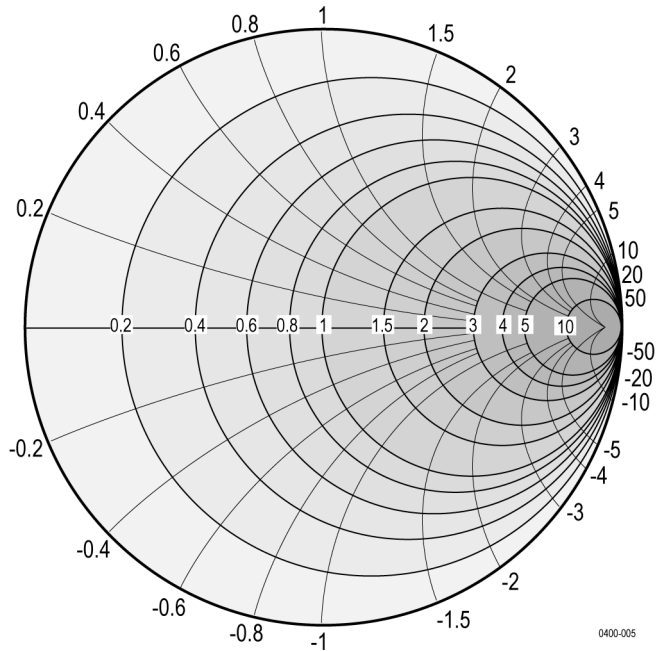

Use the Smith chart format to display these data groups:

- Linear magnitude and phase
- Logarithmic magnitude and phase
- Real and imaginary parts
- Resistance, reactance, and inductance or capacitance
- Conductance, susceptance, and capacitance or inductance

Set the scale

The scale sets the axis of the display plot in order to zoom in to points of interest or view all trace measurements for a channel simultaneously. To set the scale,

1. Set a reference position on the graph (**Response > Scale > Reference Position**).
2. Set the scale for your display:
 - [Auto scale](#)
 - [Manual scale](#)

Auto scale

For a particular trace, select auto scale to make the display window adjust the scale automatically when you resize it.

In the **Response** option group, select **Scale > Auto Scale** to scale all traces in the active channel.

Select the **Auto Scale All** option to scale traces in different channels.

Manual scale

You can make these scale adjustments manually. Set these parameters in **Response > Scale**.

Rectangular format

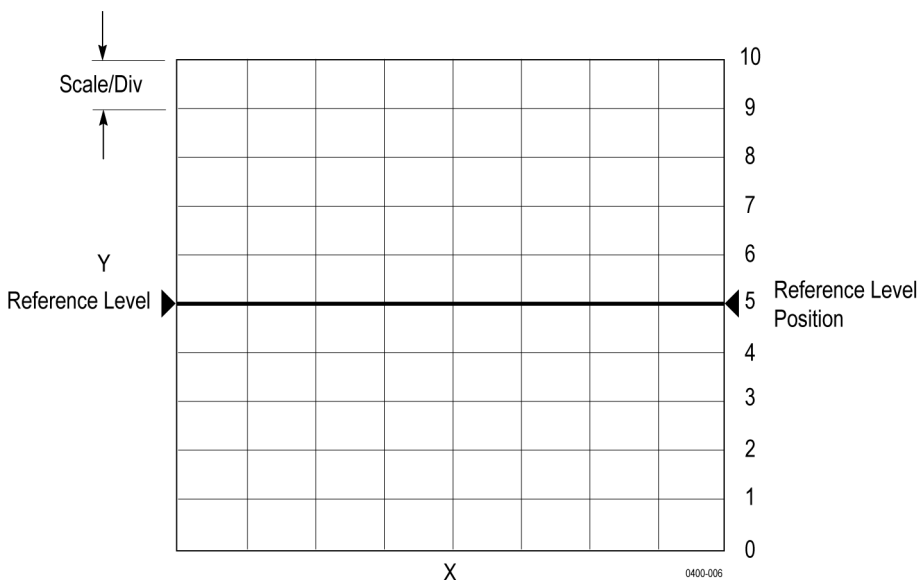

Setting	Description
Divisions	Sets the number of divisions on the Y-axis
Scale/Divisions (Scale/Div)	Sets the size of each division. Applies only to the active trace.
Reference Position	Sets the position of the reference line on the Y-axis. Applies only to the active trace.
Reference Value	Sets the value of the reference line with respect to the Y-axis. Applies only to the active trace.

Polar and Smith chart formats

In polar and smith charts, you adjust the scale by a displacement to the outermost circle. Specify this using the **Scale/Div** value in **Response > Scale**.

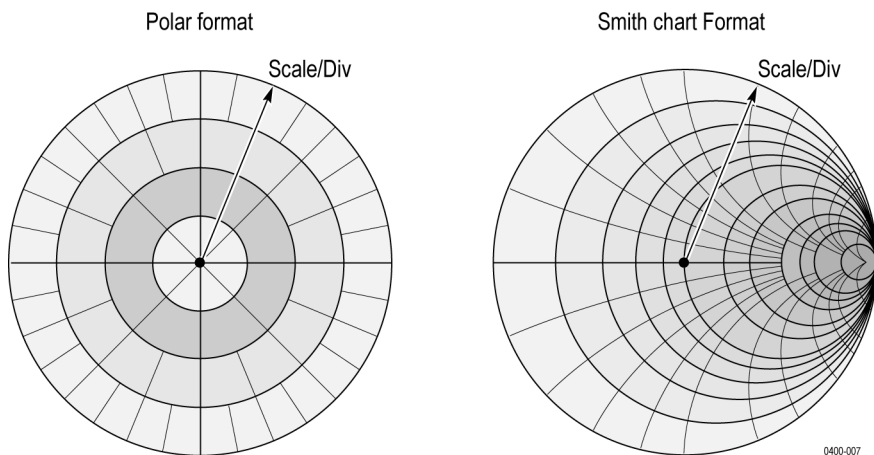

Set a reference line value

To set the measurement value at the reference position, click **Response > Scale > Reference Value**.

You can also move the reference line for an active channel to the marker response value. Select **Response > Scale > Marker → Reference**.

Set window displays

Use these options to set or clear preferences for the window display.

Operation	Soft key path
Maximize a channel or trace	<ul style="list-style-type: none"> ■ Channel / Trace > Channel > Max ■ Channel / Trace > Trace > Max
Display graticule label on the vertical axis (rectangular format only)	Response > Display > Labels > Graticule Label
Frequency information on horizontal axis (rectangular format only) and channel status bar	Response > Display > Labels > Display Frequency
Edit channel title for active channel	Response > Display > Labels > Edit Title Label
Display channel title for active channel	Response > Display > Labels > Display Title Label
Invert the display color	<ul style="list-style-type: none"> ■ Response > Display > Invert Color > Inverted sets the display against a white background ■ Response > Display > Invert Color > Normal sets the display against a black background

What is calibration?

Before making measurements with a VNA, you calibrate the VNA to reduce errors that can affect measurements. An understanding of measurement errors is useful before proceeding to calibrate a VNA because not all errors can be minimized this way. Measurement errors mainly fall into one of these types:

- Drift errors
- Random errors
- Systematic errors

Drift errors

Drift errors occur when the behavior of a test system changes after you calibrate it. Drift errors are primarily caused by temperature variation and can be removed by additional calibration. The rate of drift determines how frequently the test system needs additional calibrations. You can typically minimize drift errors by constructing a test environment with stable ambient temperature. Although you can specify test equipment to operate over a temperature range of 0 °C to +55 °C, for optimal performance, operate the VNA at +25 °C ± 5 °C. You can improve measurement accuracy and reduce or eliminate the need for periodic recalibration by minimizing drift errors.

Random errors

Random errors are unpredictable errors that occur in VNA measurements due to noise fluctuations, thermal drifts, cable bends, changes in cable dimensions, connector repeatability and other factors. These errors are usually non-repeatable. Some ways to remove random errors include careful handling of cables and connectors after calibration, proper setting of the source power, and maintaining a constant ambient temperature. These errors cannot be eliminated by calibrating a VNA.

Systematic errors

Systematic errors are more intrinsic to components and devices in the measurement system than drift or random errors. Systematic errors occur due to manufacturing imperfections in components of the measurement system. Since these errors occur every time you perform a measurement, a calibration operation can help remove systematic errors from VNA measurements.

Systematic errors in reflection measurements

Error	Description
Directivity	Besides the reflection signal, a small portion of the incident signal is received by the test receiver due to leakage in the test coupler.
Source match	The reflection signal of the DUT reflects at the signal source and reenters the DUT. The source match is determined by the quality of the source reference coupler and any mismatches between the coupler and the test port output (or DUT input).
Frequency response reflection tracking	Difference in frequency response between the test and reference receivers of a stimulus port.

Systematic errors in transmission measurements

Error	Description
Isolation (or crosstalk)	Signals other than the test signal leak into the test receiver at the transmission port.
Load match	A portion of the incident signal is reflected off of port 2 and does not get measured at the receiver at port 2. The load match is a measure of how the receiver port impedance deviates from the reference impedance.
Frequency response transmission tracking	Difference in frequency response between the test receiver of a response port and the reference receiver of a stimulus port.

When you calibrate a VNA, you perform a mathematical correction to the measurement results. This mathematical calibration is different from the instrument calibration of microwave devices. Mathematical calibration or error correction is the computation of the correction you need to apply to all four S-parameters of the test network at any frequency of interest. You compute this correction as an array of coefficients by using the VNA to measure known electrical standards at a fixed measurement plane.

Calibration workflow

When you perform coaxial measurements, you typically use Short, Open, Load, and Thru (SOLT) standards as loads connected to test ports. Using these known standards, you perform measurements to gather data and compute error correction parameters. The calibration workflow involves these steps:

1. Select a suitable calibration kit that matches the connector type of the test port. The calibration kit contains SOLT standards with known S-parameters and matched impedances.
2. Select the calibration method to apply, based on the accuracy required. The calibration method determines the extent to which the error correction will be applied to the model.
3. Compare the S-parameter measurements obtained using the VNA with the known S-parameters of the standard. Based on these measurements, the VNA determines the systematic error correction.
4. Apply the systematic error correction to measurements made on the DUT.

NOTE. You perform calibration on a single channel at a time since the operation relies on the stimulus provided to the channel.

The SOLT standards are accurate devices that you can use as standards to calibrate the VNA. The collection of standards for a specific connector type and impedance forms a calibration kit. Every standard in a calibration kit has a mathematical definition for its parameters. When you use a standard from a calibration kit in a particular calibration method, you create a calibration standard class.

NOTE. *Calibration standards of predefined kits have their classes specified. When you select a user-defined standard, make sure you specify its subclass in the dialog box of the standard.*

The calibration plane

The calibration reference plane is the imaginary plane orthogonal to the ports of the VNA at which the measurement is observed. Any adapter or cable connected to a port of the VNA is considered to be a part of the VNA and therefore included in the reference plane.

When the adapter is inside the calibration plane its systematic error effects are removed, as long as the adapter is in the same location as the VNA during measurement.

When the adapter is outside the calibration plane, you can remove the systematic error effects of the adapter from your measurements by using the S-parameters of the adapter (if they are known or can be measured).

Definitions

Term	Definition
Calibration	The process of measuring known electrical standards using the VNA to determine measurement errors and correct them.
Calibration reference plane	The imaginary plane orthogonal to the ports of the VNA at which you perform calibration.
Electrical standard	Physical devices with accurately known magnitude and phase responses that are used to calibrate a VNA. Eg: Open, short, load
Standard coefficients	The numerical characteristics of a standard, specified by the polynomial equation of the model that represents the standard. Eg: C_0, C_1, C_2, C_3 coefficients of the third degree polynomial equation that defines the capacitance model for an Open standard. $C = (C_0) + (C_1 F) + (C_2 F^2) + (C_3 F^3)$ where: C: Capacitance F: Measurement frequency
Calibration method	The procedure by which you calibrate a VNA. Eg: SOLT, TRL
Calibration kit	A collection of known electrical standards. A single calibration kit can support multiple calibration methods.
Standard subclass	A particular collection of standards in a calibration kit. Eg: a collection of male standards at port 1, SOLT standards from 2.5 GHz–3 GHz

Select a calibration kit

A calibration kit is a collection of known calibration standards. The S-parameters of these standards are documented parameters that are available at the time you perform calibration. When you select a calibration kit, make sure it matches the connector type of the test port.

The VNA is preloaded with several calibration kits. To select a calibration kit, in the **Response** option group, click **Cal > Cal Kit** and choose from the list of preloaded kits.

If you want to select a different calibration kit, you modify an empty kit according to the standards required.

See Also:

[Add/Modify a Calibration Kit](#)

Select a calibration method

You can perform these calibrations using the TTR500 series VNA. Select these methods in **Response > Cal.**

Calibration Type	Available Standards	Soft key	Errors Corrected	Measurement Parameters	Accuracy
Response calibration (Reflection)	■ Short	Calibrate > Response > Short	■ Reflection tracking	■ S ₁₁ ■ S ₂₂	Medium
	■ Open	Calibrate > Response > Open	■ Reflection tracking	■ S ₁₁ ■ S ₂₂	Medium
Response calibration (Transmission)	■ Thru	Calibrate > Response > Thru	■ Transmission tracking	■ S ₁₂ ■ S ₂₁	Medium
Enhanced response 2-port 1-path SOLT	■ Short	Calibrate > Enhanced Response	■ Reflection tracking	■ S ₁₁ , S ₂₁ (stimulus on port 1)	
	■ Open		■ Transmission tracking		
	■ Load		■ Directivity		
	■ Thru		■ Source match		

Calibration Type	Available Standards	Soft key	Errors Corrected	Measurement Parameters	Accuracy
1-port SOL	<ul style="list-style-type: none"> ■ Short ■ Open ■ Load 	Calibrate > 1-port SOL	<ul style="list-style-type: none"> ■ Reflection tracking ■ Directivity ■ Source match 	<ul style="list-style-type: none"> ■ S₁₁ ■ S₂₂ 	High
2-port SOLT Full 2-port	<ul style="list-style-type: none"> ■ Short ■ Open ■ Load ■ Thru 	Calibrate > 2-port SOLT	<ul style="list-style-type: none"> ■ Reflection tracking ■ Transmission tracking ■ Directivity ■ Source match ■ Load match ■ Isolation 	<ul style="list-style-type: none"> ■ S₁₁ ■ S₁₂ ■ S₂₁ ■ S₂₂ 	High

Calibrate the VNA

The next few sections describe procedures for every type of calibration you can perform using the VNA. You can select the calibration method in **Response > Cal > Calibrate**.

Before you perform a calibration, make sure you:

- Select an active channel for the calibration.
- Set parameters for the active channel.
- Select an appropriate calibration kit for the procedure.
- Do not have power supplies connected to the bias tee connectors.

Isolation calibration

The isolation procedure corrects a calibration for crosstalk—the signal leakage between test ports when no device is present.

When you perform an unguided 2-port calibration, you have the option of omitting the isolation portion of the calibration. The uncorrected isolation between the test ports of the analyzer is exceptional (typically >100 dB). Therefore, you should only perform the isolation portion of a 2-port calibration when you require isolation that is better than 100 dB.

Perform an isolation calibration when you are testing a device with high loss, such as some filter stop bands or a switch in the open position. The isolation calibration can add noise to the error model when the measurement is very close to the noise floor of the analyzer. To improve measurement accuracy, set a narrow IF Bandwidth.

Response calibration (Short/Open) - Reflection Test

- 1-port calibration
- Connect an Open or Short standard to a test port of the VNA to perform reflection test.
- Calibration eliminates the reflection tracking error from the network.

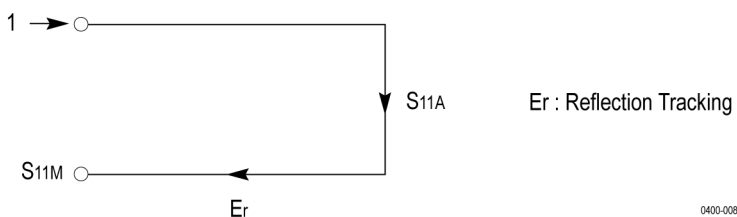

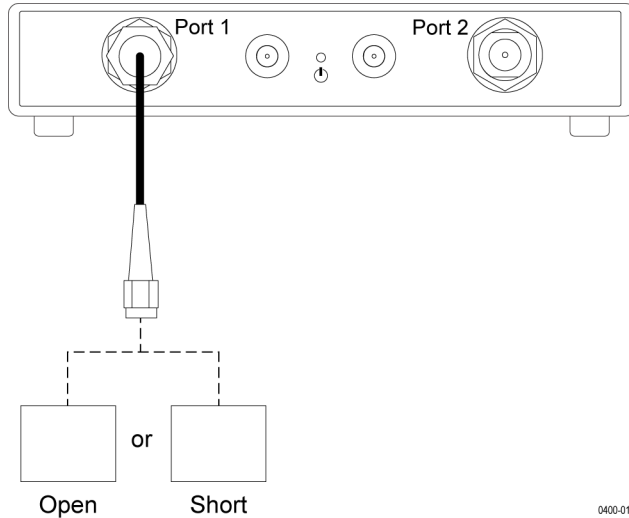

0400-014

Procedure

For the appropriate standard (short or open) that you want to calibrate,

1. In the **Response > Cal > Calibrate** menu, select **Response** calibration.
2. Select the appropriate soft key for the standard—**Open** or **Short**.
3. Select the test port to calibrate the standard. The dialog box for the port opens.
4. Connect the appropriate standard from the calibration kit to the test port of the VNA. Make sure you select the right gender.
5. In the dialog box of the port, click the appropriate standard button. The VNA records a calibration measurement. When the measurement is complete, a check mark appears next to the standard button in the port dialog box.
6. Click **Apply** to save the calibration data. The VNA calculates and saves calibration coefficients. The error correction function is also enabled.

NOTE. If you need to repeat a portion of a calibration procedure for a standard, use the *overwrite* feature to override the information recorded by the VNA for the standard. For more information, see [Partial overwrite](#).

Response calibration (Thru) - Transmission Test

- 2–port calibration
- Connect a Thru standard between the test ports of the VNA to perform transmission test.
- Calibration eliminates the frequency response transmission tracking error from the network.

- Isolation calibration (optional) using Load eliminates isolation error.

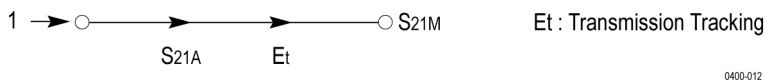
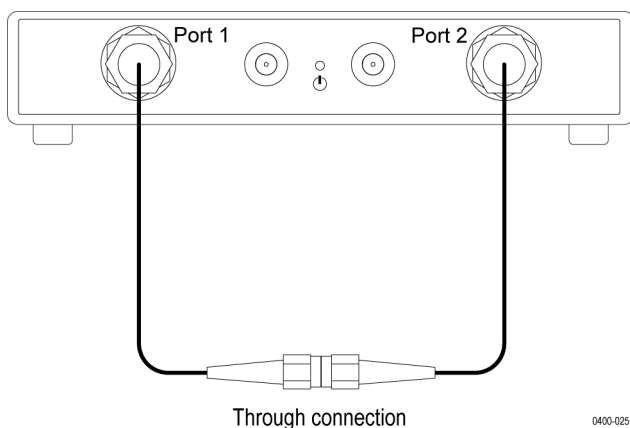

Procedure

1. In the **Response > Cal > Calibrate > Response** menu, select the **Thru** calibration.
2. Select a Thru calibration option:

When the stimulus is at port 2 and you measure the response at port 1, you measure the S_{12} parameter.

When the stimulus is at port 1 and you measure the response at port 2, you measure the S_{21} parameter.
3. Connect the Thru standard from the calibration kit to the test ports of the VNA.
4. Click the **Thru** standard button in the dialog box of the test port. The VNA records a trace measurement.

When the calibration measurement is complete, a check mark appears next to the **Thru** button in the port dialog box.
5. For an optional isolation calibration, connect the Load standard to each of the test ports. Click **Isolation** in the dialog box to make the calibration measurement.

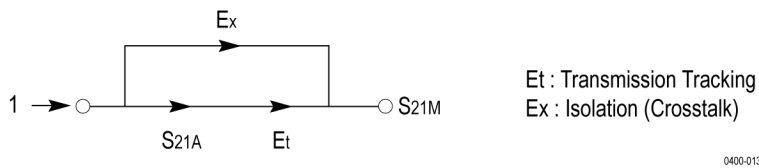
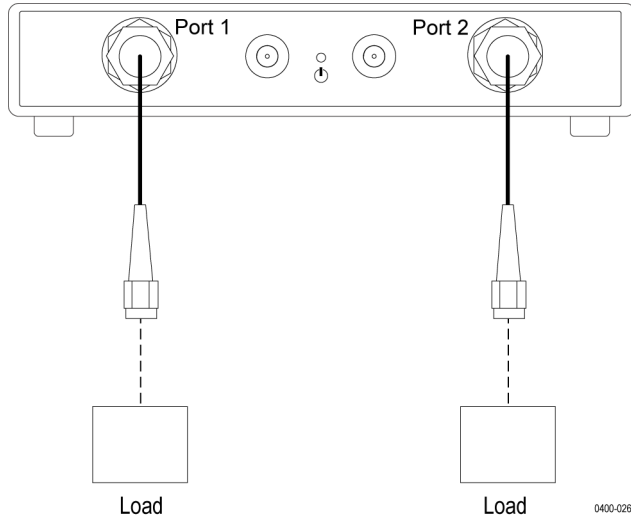

6. Click **Apply** to save the calibration data. The VNA creates and saves calibration coefficients. The error correction function is also enabled.

2-port 1-path SOLT (Enhanced Response) calibration

- 2-port calibration
- Connect Open, Short, or Load standards to stimulus port or connect Thru standard between stimulus and response ports.
- For isolation calibration, use Load on ports 1 and 2.
- Calibration eliminates directivity error, reflection tracking, source match error, transmission tracking error and crosstalk (isolation measurement) from the network.

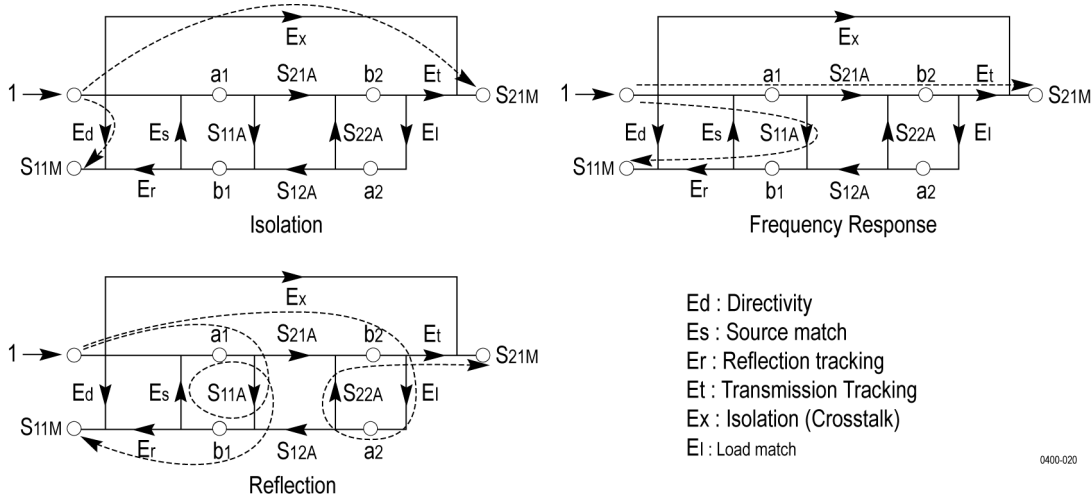

0400-020

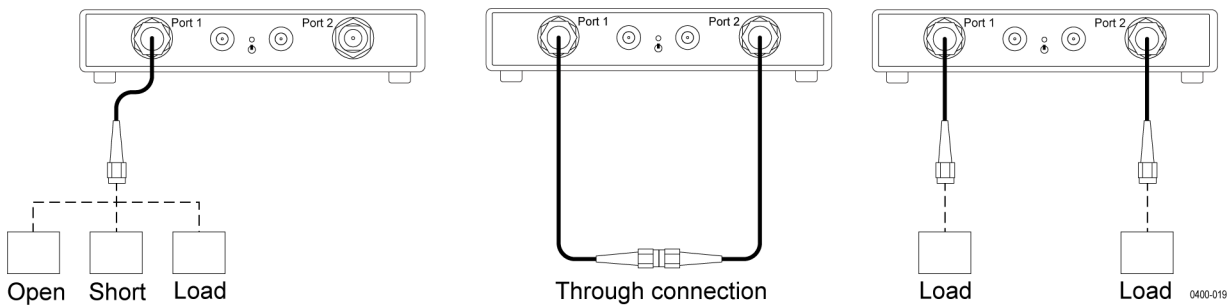

0400-019

Procedure

1. Click **Response > Cal > Calibrate** and open the **Enhanced Response** menu.
2. Select a measurement. The dialog box for the measurement opens.
 When the stimulus is at port 1 and you measure the response at port 2, you measure the S_{21} parameter.
 When the stimulus is at port 2 and you measure the response at port 1, you measure the S_{12} parameter.
3. Connect the Open standard from the calibration kit to the stimulus port of the VNA.
4. Click the **Open** standard button in the dialog box. The VNA records a calibration measurement.
 When the measurement is complete, a check mark appears next to the **Open** standard button in the port dialog box.
5. Repeat steps 3 and 4 for the Short, Load, and Thru standards. For the Thru standard measurement, connect the standard between the stimulus and response ports.

6. For an isolation calibration, connect the Load standard to each of the ports. Click **Isolation** in the dialog box to make the measurement.
7. After completing all measurements, click **Apply** to save the calibration data. The VNA creates and saves calibration coefficients. The error correction function is also enabled.

1-port SOL calibration (Reflection Test)

- 1-port calibration
- Connect Open, Short, and Load standards to test port.
- Calibration eliminates errors due to directivity, reflection tracking and source match.

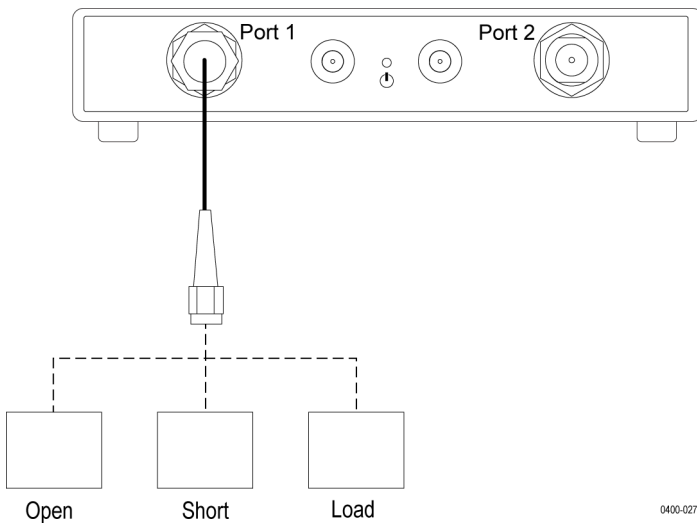
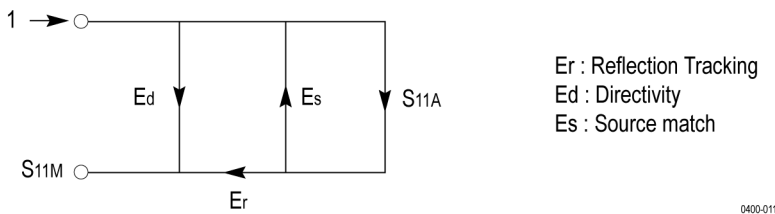

Procedure

1. Click **Response > Cal > Calibrate** and open the **1-port SOL** menu.
2. Select the test port where you perform the 1-port SOL calibration. The dialog box for the test port opens.
3. Connect the Open standard from the calibration kit to the test port of the VNA.

NOTE. You can measure the Open, Short, and Load standards in any order.

4. Click the **Open** standard button in the dialog box of the stimulus port. The VNA records a calibration measurement.
 When the measurement is complete, a check mark appears next to the **Open** standard button in the port dialog box.
5. Repeat steps 3 and 4 for the Short and Load standards.
6. Click **Apply** to save the calibration data. The VNA calculates and saves calibration coefficients. The error correction function is also enabled.

2-port 2-path SOLT (Full Two Port) calibration

- 2-port 2-path calibration
- Connect Open, Short, or Load standards to two test ports.
- Connect Thru standard between the two VNA ports. Measure both transmission and reflection in both directions.
- Measure S_{11} , S_{12} , S_{21} , S_{22} parameters
- Calibration eliminates frequency response reflectivity tracking error, directivity, source match error, load match error, transmission tracking and crosstalk (isolation measurement).

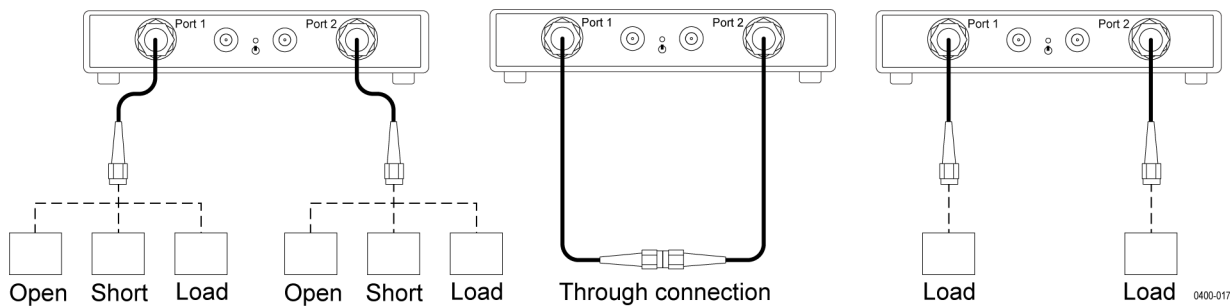

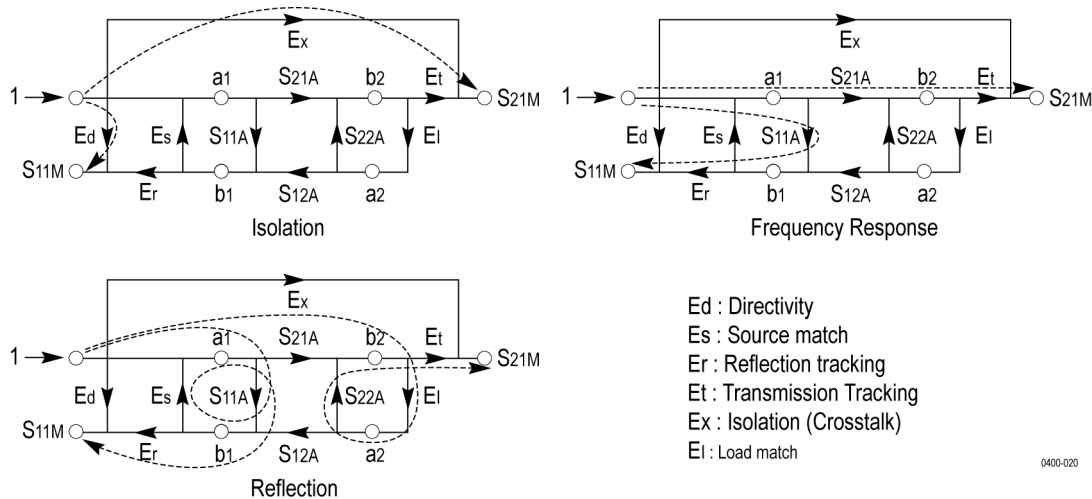

Procedure

1. Click **Response > Cal > Calibrate** and open the **2-port SOLT** dialog box.
2. Connect Short, Open and Load standards from the calibration kit to Port 1 and record their measurements using the corresponding soft keys in the 2-port SOLT dialog box.
3. Repeat step 2 to record Short, Open, and Load standard measurements for Port 2.
4. Connect the Thru standard between port 1 and port 2.
5. Click **Thru** in the SOLT dialog box to record the calibration measurement.
6. For an isolation calibration, connect Load standards to both test ports. Click **Isolation** to make the measurement.
7. Click **Apply** to save the calibration data. The VNA creates and saves calibration coefficients. The error correction function is also enabled.

Apply error correction

When you perform a calibration, the VNA enables the error correction function at the time you save calibration data. This function applies an error correction (based on the calibration) to future measurements. You apply the error correction to a channel (and consequently to all the traces it contains).

Enable error correction

To enable/disable the error correction function, in **Response > Cal**, click the **Correction** soft key. You can see the status of the error correction function:

- In the data entry bar after you click **Response > Cal.**
- In the channel status bar.

This table lists the settings for the error correction function:

Status	Description
No Data	No error correction data exists. Calibrate the VNA to obtain an error correction.
Cor	Error correction function is on.
!	Parameters do not match.
*	Error correction is interpolated

NOTE. *You must have calibration data to enable the error correction function.*

Distinction from factory error correction function

The error correction function described here is different from the factory error correction in the VNA. The factory error correction automatically applies to all measurements. The factory correction is useful when performing measurements without calibrating the instrument first. Proper calibration of the instrument eliminates the need for the factory error correction.

The error correction function is more specific to the active measurement performed with the VNA.

See Also:

- [Disable factory error correction](#)

Apply port extensions

When you use fixtures to connect the VNA to the DUT, these fixtures can also contribute to measurement errors. To account for the delay of the test fixture, you can move the calibration reference plane. The new calibration plane then exists at the terminals of the DUT. You do this by applying port extensions.

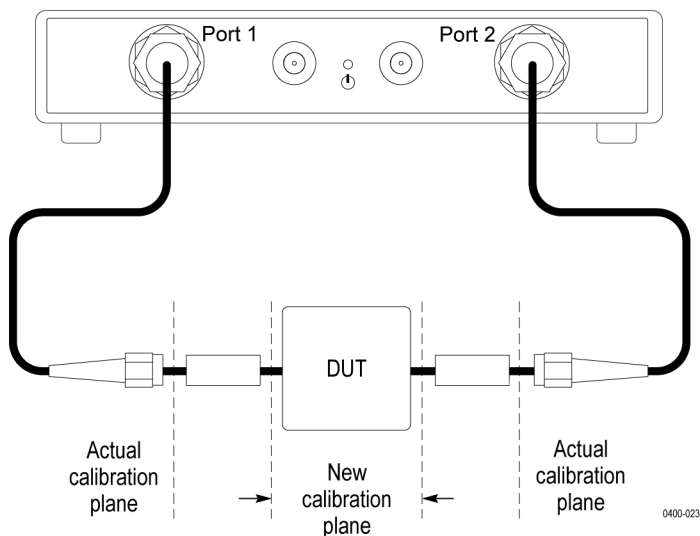

Port extensions are useful when:

- You cannot connect a DUT directly to the test ports at the calibration plane. You can use port extensions to calibrate the VNA at a convenient location. The VNA can compensate for the time delay and other fixture losses.
- You have calibrated the test system and you need to add a length of transmission line to the configuration. Use port extensions to configure the length of transmission line in the VNA to account for the losses introduced by the transmission line.

Procedure

1. Open the **Port Extension** dialog box in **Response > Cal**.
2. Check **Enable Port Extension**. This applies the port extension calculation to measurements. When the calculation is complete, use the check box to apply/remove the length and loss and compare results.
3. Specify delay and loss values for the test port(s). In general, single port extensions apply to 1-port measurements (S_{11} , S_{22}). Specify delay and loss values for both ports when performing 2-port measurements (S_{11} , S_{22} , S_{12} , S_{21}).

If you know the physical length of the fixture or transmission line, specify this as the **Delay Length**. If you know the electrical length instead, specify this as the **Delay Time**.

4. Enter the **DC Loss** value. This should offset the frequency span in the positive direction.
5. For **Loss 1**, specify the loss (in dB) and frequency for the lower frequency limit in the sweep. For **Loss 2**, specify the loss (in dB) and frequency for the higher frequency limit. Use the check boxes to enable/disable the loss values and compare how that affects your measurement.
6. Specify the **Velocity Factor** for the medium of extension. Typical values are:

Medium	Velocity Factor
Polyethylene dielectric cable	0.66
PTFE Dielectric	0.7
Foamed polyethylene dielectric	0.82
Light in vacuum	1

7. Select the medium of the extension.

- For a coaxial medium, you must also specify the velocity factor.
- For a waveguide medium, you must also specify the cutoff frequency.

Loss calculation

These equations describe how the values of **Loss1** and **Loss2** (losses at the lower and higher frequency limits in dB) affect the calculation of losses compensated by applying port extensions.

When Loss2 is specified:

The total loss at frequency f is given by

$$Loss = DC Loss + Loss_1 * \left(\frac{f}{f_1}\right)^n$$

where:

$$n = \frac{\log_{10} \left| \frac{Loss_1}{Loss_2} \right|}{\log_{10} \frac{f_1}{f_2}}$$

When Loss2 is not specified:

The total loss at frequency f is given by

$$Loss = DC Loss + Loss_1 * \sqrt{\left(\frac{f}{f_1}\right)}$$

Partial overwrite

In cases where you need to repeat a portion of the calibration procedure, for example a particular standard, use the partial overwrite feature. The new measurement overrides the data previously recorded for that standard. The VNA recalculates the calibration coefficients. Partial overwrite can happen only after completing a calibration procedure. Use this feature when you want to do a partial recalculation of calibration coefficients for a standard.

For example, if you are performing a 2–port SOLT calibration:

1. In **Response > Cal > Calibrate**, click **2–port SOLT**. Open the dialog box for the calibration.
2. Step through Open, Short, and Load standard calibrations for port 1 and port 2.
3. Click **Thru**. You can now repeat calibration measurements for the two ports.
4. Click **Overwrite**. The VNA stores the second set of measurements and uses them to recalculate calibration coefficients.

NOTE. *You cannot use the partial overwrite feature to add additional calibration coefficients to a calibration procedure. You can only update calibration coefficients that have already been calculated. For example, if you perform a 1–port calibration, you cannot use the overwrite feature for the other port to convert the 1–port procedure into a 2–port calibration.*

Manage calibration kits

The VNA is preloaded with 7 calibration kits. There are 13 additional empty kits that you can use to create your own calibration kits. Adding a kit or modifying an existing one can be a useful option when you need to:

- Add a new calibration standard to a kit.
- Improve the parameters of a calibration standard.
- Assign a different port to a standard for connector matching.

Add/Modify a calibration kit

You add a calibration kit to the VNA by selecting an empty kit and modifying it. You can also use empty kits to modify a preloaded calibration kit to change standards or parameters.

Since a calibration kit is a collection of standards in different subclasses (for various calibration procedures), when you add a calibration kit, you must:

1. Define calibration standards.
2. Specify subclasses for the standards.

Define a calibration standard

To define a calibration standard, you must specify its calibration coefficients. You can define them in two ways:

- Model-based definition – Use coefficients of the nth degree polynomial equation that defines the model of the standard.
- Data-based definition – Obtain this information from the datasheet of a kit or import a touchstone file (S1P, S2P) that describes the standard.

Once you have the calibration coefficients,

1. In **Response > Cal > Cal Kit**, select an empty user kit from the data entry bar. These are numbered 1–13.
2. Once you have selected a calibration kit, modify it by clicking **Cal > Modify Cal Kit**.
3. Define a calibration standard. Select **Cal > Modify Cal Kit > Define Standards**. Select a standard and enter values for settings in the dialog box.

Section	Parameter	Description
Identification	Label	Name of standard
	Type	Type of standard. Select from: <ul style="list-style-type: none"> <input type="checkbox"/> Open <input type="checkbox"/> Short <input type="checkbox"/> Load <input type="checkbox"/> Thru <input type="checkbox"/> Unknown Thru <input type="checkbox"/> Arbitrary <input type="checkbox"/> None
File	File name	Import a touchstone file (S1P, S2P) that contains S-parameters and other information about the standard. Select this option for a data-based standard definition.
Frequency Range	<input type="checkbox"/> Min	Define the complete frequency range of the standard. For a waveguide, the cutoff frequency is the minimum frequency.
	<input type="checkbox"/> Max	
Media	<input type="checkbox"/> Coaxial	Define the medium of the standard.
	<input type="checkbox"/> Waveguide	
Common Characteristics	Delay	Electrical delay
	Loss	Offset loss
	(Z ₀)	Characteristic impedance <ul style="list-style-type: none"> <input type="checkbox"/> 50 Ω (coaxial) <input type="checkbox"/> 1 Ω (waveguide)
Open Characteristics	<input type="checkbox"/> C ₀ , C ₁ , C ₂ , C ₃	Calibration coefficients
	<input type="checkbox"/> L ₀ , L ₁ , L ₂ , L ₃	

Specify a subclass

A subclass is a grouping of standards. A set of standards can be grouped in several different subclasses for different calibration procedures. Each subclass must cover the entire frequency range of the calibration of the standard. However, you can use individual standards to cover sections of the frequency range.

Different VNAs support different calibration kits and standards so you may need to redefine a calibration kit when you import it. Since calibration standards are defined for 1 and 2 ports, standard subclasses are also defined for 2-ports.

1. Select **Response > Cal > Modify Cal Kit > Specify Subclass**.
2. Select a subclass to modify. You can set an existing subclass (Male-Male DUT) or pick an empty subclass. The subclass dialog box opens.

3. Specify the SOLT or TRL standard settings for port 1 and port 2. Click **Apply** to save the subclass.
4. During calibration, when you select a user-defined standard, make sure you specify the subclass in the **Subclass Id** field.

NOTE. *When subclasses overlap for a portion of the frequency range of operation of a standard, the subclass used for the most recent standard collection determines the calibration data stored by the VNA.*

For example, if subclass 1 measures the response from 100 kHz-2 GHz and subclass 2 measures the response from 1 GHz-4 GHz, the subclass 2 calibration data is stored by the VNA for the overlapping frequency range of 1 GHz-2 GHz.

Label the calibration kit

After you create standards and specify subclasses for them, select **Response > Cal > Modify Cal Kit > Label Kit**. Enter a name for the new calibration kit and save it.

Additional calibration kit operations

Task	Action (in Response > Cal)
Import a calibration kit file (from system or another analyzer)	Cal Kit > Import
Export calibration kit file	Cal Kit > Export
Clear calibration data from the VNA	Clear

Calibration trigger source

In the default operating mode, you can select a trigger for measurements whereas calibration uses an internal trigger. However, when you need to position or switch external hardware, you can set the calibration trigger to be identical to the measurement trigger.

In **Response > Cal > More > Cal Trig Source**, set the calibration trigger to **System**.

Power calibration

For a more accurate calibration where the power output is closer to the set value or to compensate for losses in external cabling and fixtures, use the power calibration feature. This option uses a power meter to measure the power level and it uses calibration data to perform error correction. The accuracy of the power setting at the point of calibration is fixed by the power meter. The accuracy and range of measurement can be limited by the power meter as well as by the power supplied. Set the channel frequency range according to the supported frequency range of the power meter.

Power calibration applies to each port of the VNA so you can turn this feature on or off for each port independently. You can also use different power meters at the two ports.

Power calibration workflow

In the power calibration workflow, you perform these steps:

1. Connect a power meter to the VNA at the test location where the cables and fixtures connect to the DUT.
2. Configure the VNA for power calibration.
3. The power meter measures power at every frequency in the specified range and adjusts its output to the selected power level.
4. Once the calibration is complete, you can save the power meter data as part of the VNA state data. Remove the power meter. VectorVu-PC now applies the calibrated power data to all connections at this port.
5. If you perform an S-parameter calibration with power correction turned on, the calibration uses the power levels determined in the previous step.

Requirements

Review these requirements before you begin the power calibration procedure:

Power meters

Select one of these supported models:

Manufacturer	Type	Models
Tektronix	USB	■ PSM3000 series
		■ PSM4000 series
		■ PSM5000 series
Rohde & Schwartz	USB	■ NRP-Z power meters
		■ NRP-xxS/SN power meters
Keysight	USB	■ U848x series
		■ U2000 series
		■ U2020 series

Loss compensation table

Prepare a loss compensation table in comma-separated value (CSV) format to account for the fixture losses at every frequency. The first column indicates frequency (Hz) and the second column indicates

the corresponding power loss (dB). Frequencies must be in ascending order and the file must contain at least 2 sets of entries.

10.00E+6	2
1.00E+9	2
2.00E+9	3
3.00E+9	3
4.00E+9	4

Power calibration factor table

Prepare the power calibration factor table in CSV format. This is a table of frequencies (Hz) and corresponding calibration factor values (%). The calibration factor indicates the percentage of power transmitted to the power meter and not reflected back to the fixtures.

10.00E+6	99
1.00E+9	99
2.00E+9	93
3.00E+9	90
4.00E+9	89

Frequencies must be in ascending order and the file must contain at least 2 sets of entries. If you do not specify calibration factors for specific frequencies, you can also provide a Reference Calibration (RC) Factor that applies globally to every frequency in the table.

Procedure

1. Connect the USB cable of the power meter to the computer.
2. Connect the measurement port of the power meter to the test location. The test location includes all cables and fixtures between the VNA and the DUT.
3. In **Cal > Power Calibration**, select the port where you want to perform power calibration.
4. Click **Configure**. In the power calibration dialog box, you enter parameters to set up power calibration for the selected port.
5. Refresh the **Model Address** field. The VNA detects the power meter connected to your system.
6. Specify the averaging factor. This refers to the number of power calibration measurements to be averaged at a single point.
7. Specify a tolerance value. This value should be large enough to accommodate losses in frequency response due to cables and fixtures. When consecutive power measurements are within this range, the power meter settles on the measurement and the VNA stores this reading.
8. If you want to compensate for losses in fixtures and cables, check **Enable Loss Compensation**. Select a CSV file that contains the loss compensation data.

9. In **Sensor Calibration**, select a CSV file that contains the power calibration factor table for the sensor. If the table does not contain individual calibration factors, specify an **RC factor** that applies globally to all entries in the table.
10. Apply these settings. You can save them as part of the instrument data in a state file (*.state or *.cstate) format.
11. After configuring the power measurement, you can measure S-parameter measurements for the DUT using the corrected power levels for stimulus. Select **Cal > Power Calibration > Calibrate**.

You can now enable or disable power calibration by toggling the **Correction** soft key. The correction applies to any connection you make at this port.

Receiver calibration

When you measure active devices that require accurate absolute power (like amplifiers or frequency converters), use receiver calibration to calibrate the gain of the individual receivers. In this calibration:

1. You perform a power calibration on the source port. This procedure corrects the output power of the source port by compensating for:
 - Power loss in the VNA.
 - Losses in cables and fixtures connected to the source port.
2. You connect the calibrated source port to the receiver port of the VNA (thru connection). The receiver port can include cables, fixtures, and other hardware.
3. Perform receiver calibration. Through this procedure, you move the calibration reference plane to the point where the receiver test port is connected to the calibrated test port.

NOTE. *You must complete a power calibration before performing a receiver calibration.*

Procedure

1. Complete a power calibration on the source port.
2. In **Response > Cal > More**, select **Receiver Calibration**.
3. Select **Calibration**. The Receiver Calibration dialog box opens.
4. Select the receiver and source ports.
5. Click **Calibrate**. Once the calibration is complete, the error correction is enabled on the receiver port. You can disable it in **Receiver Calibration > Error Correction**.

See also:

- [Power calibration](#)
- [The calibration plane](#)

Unknown thru calibration

When the thru standard for a calibration is either undefined or unavailable at the test location, use the unknown thru calibration feature. When you define a thru standard, you specify delay and loss characteristics for the standard and therefore, you need to know these values at the time of definition. In the unknown thru calibration, the VNA allows you to define a thru standard without specifying these parameters.

Use unknown thru calibration when:

- You cannot define or measure in advance the attributes of a thru standard.
- The test reference planes are fixed and cannot be moved to connect a known thru standard (like a waveguide).

In **Response > Cal > Modify Cal Kit > Define Standards > Thru** select the **Unknown Thru** option.

The unknown thru loss impacts the accuracy of the calibration, and hence the measurement accuracy. The unknown thru must be reciprocal ($S_{21}=S_{12}$).

NOTE. *The accuracy of a Thru standard with specific delay and loss characteristics is always higher than the accuracy of an Unknown Thru standard.*

Set trigger for measurement

You can set the VNA to perform a sweep or point measurement every time the VNA detects a trigger signal. You can also use triggers to synchronize measurements with external events (like closing switches) or equipment.

To set triggers for measurements,

1. [Set a trigger source](#) (applies to all channels).
2. [Set a trigger mode](#) for every channel.
3. [Set the trigger scope](#).
4. Generate the trigger.

Sweep order in each channel

- Trigger signals sweep through a frequency range until all traces in the channel have been triggered.
- Within a channel, the trigger signal sweeps through traces sequentially in source-port order. So, for a 2–port measurement, the trigger signal sweeps the traces of source port 1 (S_{11} and S_{21}) simultaneously. This is followed by the sweep of traces of source port 2 (S_{22} and S_{12}).
- Once a channel has been completely triggered (all traces swept), the trigger applies to the next channel that is not in a hold state.

The trigger sweep order applies to all trigger modes.

Set a trigger source

You use the trigger source to generate a trigger signal that initiates the measurement. Select a trigger source in **Stimulus > Trigger > More > Trigger Source**.

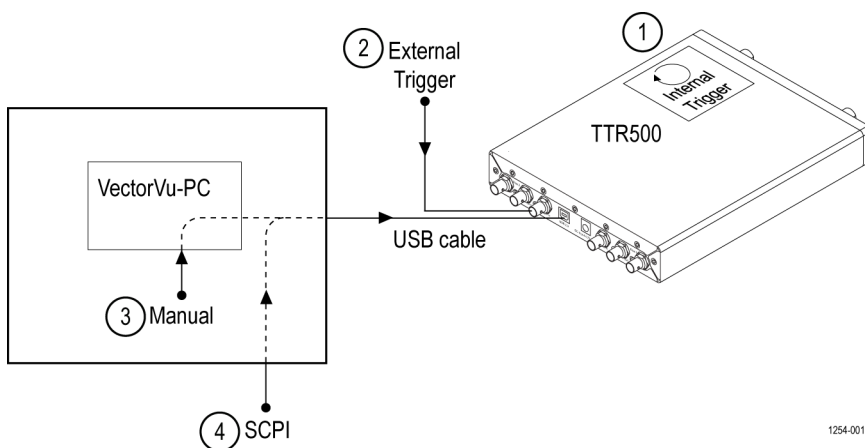

1254-001

No.	Source	Description
1	Internal	The TTR500 VNA hardware generates an internal signal. This is the basic mode of operation for continuous sweep.
2	External	Connect an external trigger signal directly to the TTR500 device using the BNC cable. Connect to Trigger In port of rear panel.
3	Manual	In Stimulus > Trigger > More , press the Trigger button to initiate a sweep. Upon receipt of the trigger request, VectorVu-PC relays the trigger request to the TTR500 hardware through the USB cable that connects the VNA to the computer.
4	SCPI	Execute the *TRG SCPI command through a programmatic interface. VectorVu-PC detects the command and sends the trigger to the VNA via the USB cable that connects the VNA to the computer.

NOTE. When you provide a manual trigger or select the SCPI source, the trigger pulse is generated through VectorVu-PC. There is an execution time involved as the pulse passes through the workstation running VectorVu-PC and the USB cable connecting it to the TTR500 device.

Measurement and calibration trigger sources

In the default operating setting, the trigger source for a sweep measurement is different from the calibration trigger source. See [Calibration trigger source](#) for more information.

Set a trigger mode

Set the trigger mode for every channel to control its trigger operation. When you set the trigger mode for a channel, you also set the state of the channel for the trigger sweep. Select a trigger mode in **Stimulus > Trigger**.

Mode	Sequence of operation
Hold	<ul style="list-style-type: none"> ■ Pause the sweep on the active channel and hold it in idle status. ■ VNA ignores triggers in this mode.
Single sweep (Single)	<ul style="list-style-type: none"> ■ VNA is in hold state. ■ Click Trigger > Single to change to armed state and await trigger. ■ VNA performs a sweep upon trigger and returns channel to hold state.
Continuous sweep (Continuous)	<p>This is the default mode.</p> <ul style="list-style-type: none"> ■ VNA is always in armed state (never in hold state). ■ Trigger signal causes VNA to perform a sweep and return to armed state. ■ Repeat sweep every time trigger source detects a trigger signal.

Mode	Sequence of operation
Hold All Channels	■ Set the mode for all channels to Hold .
Continuously display channels (Continuous All Channels)	■ Set the mode for all channels to Continuous .

NOTE. *The hold state is an idle state for the VNA where all activity is frozen and triggers are ignored. You can switch to single or continuous mode from the hold state by selecting either option in the Trigger menu.*

Set the trigger scope

Set the scope of the trigger to apply to all channels (default setting) or only the active channel.

You can set this in **Stimulus > Trigger > More > Trigger Scope**.

See Also

- [Additional trigger options](#)
- [Averaging](#)
- [Sweep time calculation](#)

Additional trigger options

Point trigger

Use the point trigger feature to obtain a point measurement instead of a sweep measurement at each trigger event. The generation of trigger signals causes the VNA to record measurements one frequency point at a time.

Click **Stimulus > Trigger > More > Point Trigger** to enable point trigger mode.

External trigger delay

You can set a delay to the external trigger signal. In **Stimulus > Trigger > More > Ext Trig Delay**, set a delay within the range of 0–1 second. Upon receipt of a trigger signal, the triggering action is delayed by this time.

Use the external trigger delay function to handle electrical or mechanical delays in external equipment involved in the test setup.

See Also

- [Averaging](#)
- [Sweep time calculation](#)

Averaging

You can set the VNA to record an average of measurements per frequency point. In **Response > Avg**:

1. Select **Averaging** and enable the function.
2. Select **Factor** and specify a value for the averaging factor. This is the number of measurements to average at a frequency point.

Averaging and triggers

When you enable averaging,

1. Each trigger causes the VNA to complete a frequency sweep measurement and average it with any previous sweep measurement(s) recorded.
2. A counter in the instrument status bar displays a ratio of the number of sweep measurements recorded (n) over the specified averaging factor (m). The counter increments every time you generate a trigger, until the averaging factor is reached.
3. Once the averaging factor is reached, any additional trigger(s) causes the VNA to perform a sweep measurement and calculate a weighted average with all previous sweeps.

Averaging with point trigger

The behavior is similar to averaging in normal triggered mode with the exception that each trigger causes the VNA to complete a measurement at a frequency point instead of a full sweep. The VNA averages at each frequency point before moving to the next point.

Averaging trigger function

When point trigger is disabled, the averaging trigger function allows you to perform a single sweep per trigger signal where every point on the sweep is averaged as many times as specified in the averaging factor. Click **Response > Avg > Avg Trigger** to enable the feature.

NOTE. *You must have the averaging function enabled to use the averaging trigger.*

When point trigger is enabled, the averaging trigger function causes the VNA to complete as many measurements as the averaging factor at a single frequency point. Successive triggers cause the VNA to advance to subsequent points.

See Also

- [Set trigger for measurement](#)
- [Additional trigger options](#)
- [Sweep time calculation](#)

Sweep time calculation

Continuous sweep

In the continuous sweep mode, the time taken to complete a sweep through n frequency points is calculated as:

$$T_{sweep} = C_0 + C_1 + C_2n + \frac{C_3n}{IFBW}$$

Continuous sweep measurement

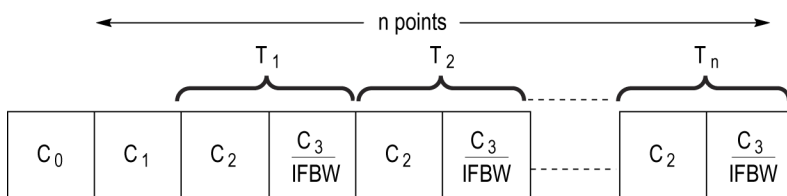

1254-002

where:

n : Number of points in sweep

C_0 : Sweep delay

C_1 : Time required to set up a sweep

C_2 : Time required to set up each point in a sweep

$C_3/IFBW$: Time required to make a measurement at a frequency point. This value is inversely proportional to the IFBW.

T_n : Total time required to complete a measurement at n th frequency point

Trigger sweep

When you make a trigger sweep measurement, the sweep begins at the falling edge of the trigger pulse. Any delay provided to the trigger signal (through **Stimulus > Trigger > More > Ext Trig Delay**) applies between the detection of the trigger signal and the sweep delay.

Sweep measurement with trigger

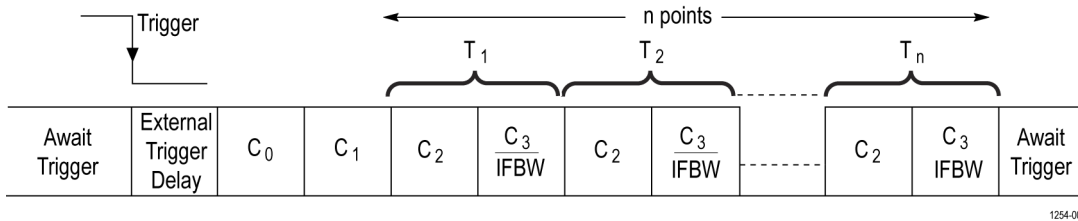

$$T_{sweep} = T_{ext} + C_0 + C_1 + \left(C_2 + \frac{C_3}{IFBW} \right) n$$

where:

T_{ext} : External trigger delay

See Also

- [Set trigger for measurement](#)
- [Additional trigger options](#)
- [Averaging](#)

Use markers on a trace

A marker reads the numerical value of a stimulus and the corresponding response value on a trace. In the rectangular format, the stimulus value is read off the X-axis and the response value is read off the Y-axis. In the polar and Smith chart formats, the stimulus value is on the X-axis. The corresponding marker on the chart represents the main and auxiliary value of the measured response value.

You can add up to 9 markers on a trace. You use markers to:

- Read the measured response for a stimulus at any point on the trace.
- Adjust the scale by setting the reference line to the marker position.
- Search for a point on the trace.
- Move to a specific point on the trace.
- Change stimulus parameters.
- Analyze trace parameters.

For a particular trace on a channel, to add a marker:

1. In the **Markers/Analysis** option group, select **Setup**.
2. Select a marker (1–9).

You can also set a reference marker in **Setup > More** by selecting the **Ref Marker** option.

See Also

- [Set up marker display](#)
- [Reference markers](#)

Set up marker display

These topics cover several display settings you can select for markers:

- [Select a display mode](#)
- [Relative value display \(Delta mode\)](#)
- [Couple/Decouple markers](#)

Marker display format

When you add a marker to a trace, the marker appears as a pair of triangles – one on the trace at the specified frequency value and the other on the X-axis (rectangular format) or base of the plot (Smith or Polar formats). The marker data (stimulus and response values) are displayed in the upper left corner of the respective channel display.

In the rectangular format, the marker data shows the measured response and stimulus values.

In polar and Smith chart formats, the marker data shows these parameters.

Data Format	Marker data (response value)	
	Main value	Auxiliary value
Smith chart – Lin/Phase	Linear amplitude	Phase
Smith chart – Log/Phase	Log amplitude	Phase
Smith chart – Real/Imag	Real component	Imaginary component
Smith chart – R+jX	Resistance	Reactance
Smith chart – G+jX	Conductance	Susceptance
Polar – Lin/Phase	Linear amplitude	Phase
Polar – Log/Phase	Log amplitude	Phase
Polar – Real/Imag	Real component	Imaginary component

Select a display mode

Where you can place a marker on a trace depends on the display mode you select for the marker.

In the discrete mode, you can place markers only on actual measurement points and not those points interpolated between them. If the stimulus value is a specific numerical value, the VNA places the marker on the measurement point that is nearest to the value (unless the value falls on a measurement point).

In the continuous mode, you place markers on actual measurement points as well as the interpolations that happen between them.

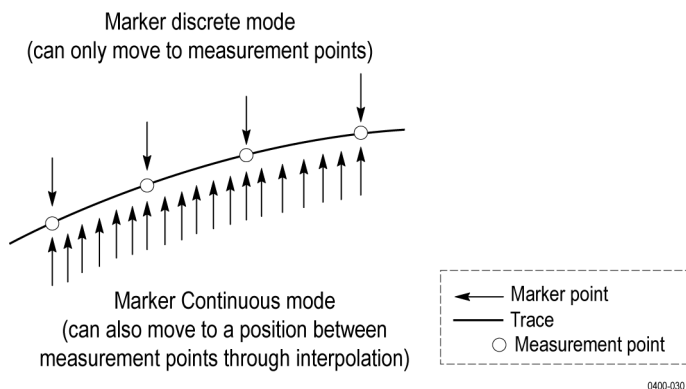

Select one of these modes in **Markers/Analysis > Function > Discrete**.

Relative value display (Delta mode)

In the default mode, a marker displays the response value relative to the origin of the chart. In the delta mode, you set a reference marker to display marker data relative to that reference point. The marker data displays the deltas on the axes relative to the reference marker.

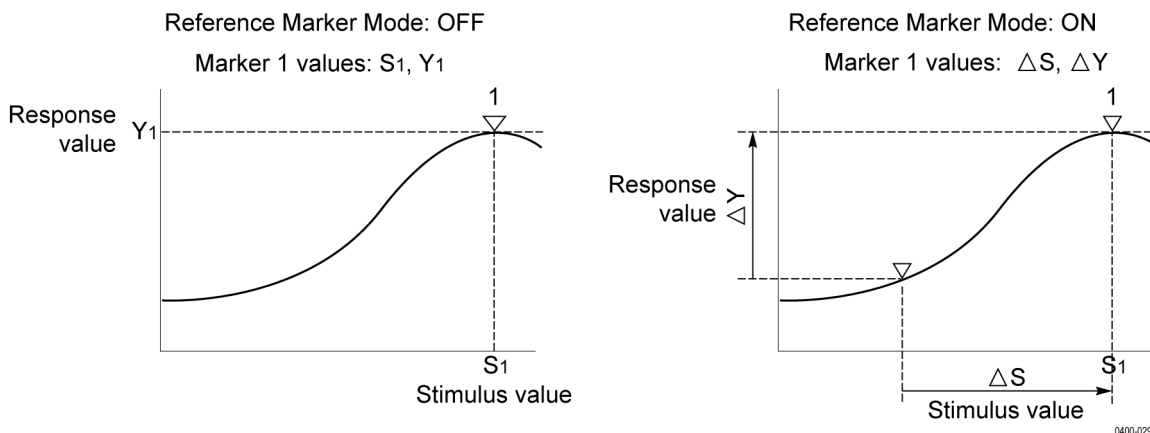

1. Set a reference marker on a point of interest. In **Markers/Analysis > Setup > More**, select **Ref Marker** and assign the marker to a reference point.
2. Add markers to the trace. Select from 1–9.
3. In **Markers/Analysis > Setup > More > Delta mode**, select delta mode in the pull down menu. The marker data displays the relative difference between its value and the reference. A delta sign appears in the marker information in the display graph.

Couple/Decouple markers

When you set up the same marker number to different traces on the same channel, you can couple and move them together or you can choose to move them independent of each other. Turn coupling on or off in **Markers/Analysis > Function > Couple**. The coupling happens between markers of the same index across all traces in the channel. For example, if marker 3 on trace 2 is set to be coupled, then marker 3 on all traces move together. Correspondingly, if the marker has a tracking search configured, then all coupled markers move with it on each new sweep.

You cannot couple markers across different channels. Marker couplings are independent from each other.

Marker search operations

Use options in **Markers/Analysis > Search** to perform these search operations:

- [Target points on the trace](#)
- [Peak points on the trace](#)
- [Bandwidth of the trace](#)
- [Bandwidth using notch search](#)

When you perform a marker search operation on a trace, the VNA moves the marker from its current position to the new measurement point located through the search operation.

Set search range

In the **Search Range** option set, you can search for points on the entire range of a sweep (**Entire sweep range**) or a part of it (**Arbitrary range**).

If you choose to search a portion of the sweep range, specify the range using **Start** and **Stop** options in the **Search Range** option set.

You can also choose to couple or decouple multiple traces for the search operation. In this case, the coupling happens between markers of the same index across all traces of the same channel. Therefore, you can have a marker on each trace with a search configured for it. You can then define the search range for all of these markers in one place.

Maximum and minimum values

When you search for the maximum (**Max**) and minimum (**Min**) measured response values on the trace in **Markers / Response > Search**, the VNA moves the marker to the respective stimulus values.

In Smith or polar formats, you search for the measured response value only.

Search tracking

Set the **Markers / Analysis > Search > Tracking** function for the VNA to perform a search operation every time a sweep is completed.

When search tracking is off, the VNA performs a search at the moment it is configured, and the marker stays at the search location even when the sweep changes. When you enable search tracking, the VNA executes a search at the end of each sweep, and the marker moves accordingly. Therefore, if you have a marker configured to search for the maximum value on a trace, the marker moves to the maximum point, on the next sweep, the maximum point could be elsewhere on the trace. With search tracking enabled, the VNA executes the search again on a new sweep measurement and the marker moves to the maximum point on the new sweep.

Target search

You perform a target search when you search for a specific point on the trace whose measured value matches the specified target.

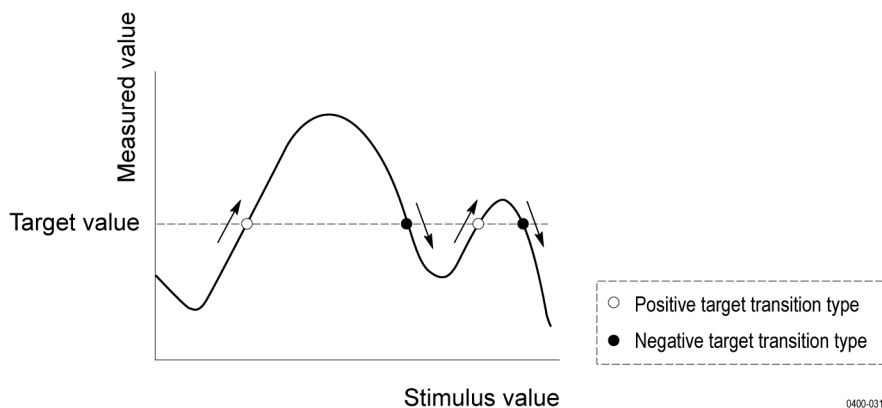

1. Select **Markers/Analysis > Search > Target**.
2. Specify a **Target Value** to search on the trace.
3. Specify a **Target Transition**. A positive transition is along those edges where successive points are numerically higher than preceding points. A negative transition occurs when successive points are numerically lower than preceding points. When you select both transitions, you search both positive and negative transitions.
4. Click **Search Target**.

Besides the target transition, you can also specify the direction of the search (**Search Left / Search Right**) from the position of the marker. When you specify the direction, you execute the search and the marker moves to the new point.

The search target operation returns the matching target that is nearest to the current location of the marker. If the current location of the marker matches the target, the marker does not move. The **Search Left / Search Right** functions return the nearest matching target in the relevant direction, even if the current point also matches the target. When you clicking **Search Left** or **Search Right** repeatedly, the marker moves in the corresponding direction from the first matching point to the next.

NOTE. *When you use target search, regardless of continuous or discrete mode, the search returns the nearest measurement point that satisfies the specified conditions of target value and transition type.*

Peak search

A peak is a measurement point on the trace that is either higher (**positive**) or lower (**negative**) than points on either side of it.

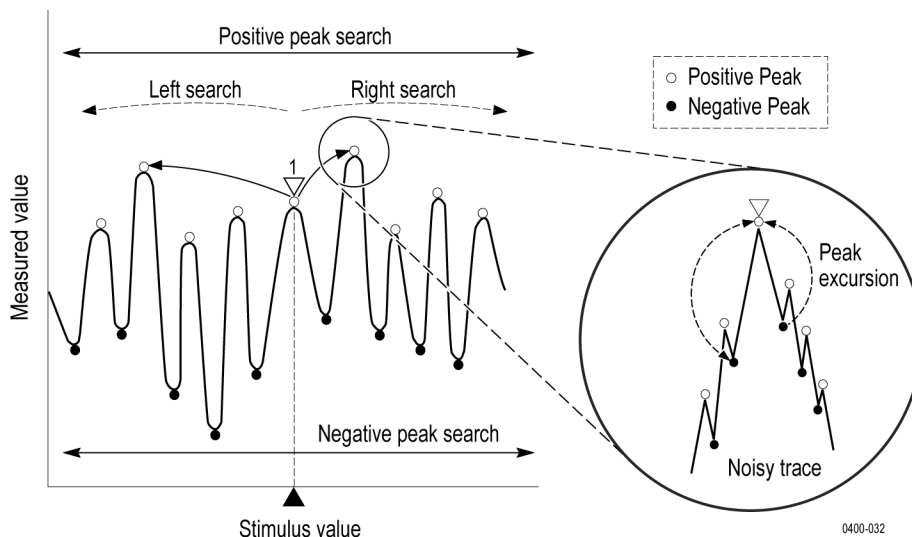

To perform a peak search (**Markers / Analysis > Search > Peak**),

1. Specify a **Peak Excursion** value. This is a parameter that is useful when searching for peaks in noisy traces. Use peak excursion to disregard noisy peaks and locate only those peaks that are relevant to your search. Mathematically, this is the smaller of the differences of the adjoining peaks of opposite polarity from the measured point.
2. Specify a **Peak Polarity** to search for positive, negative or peaks of both polarities from the current marker position.
3. Specify the direction (**Search Left** or **Search Right**) in which you are searching for the next peak.

The VNA moves the marker to the first peak encountered in that direction that meets all the criteria. Note that this may not necessarily be the peak with the largest deviation.

In the Smith and polar formats, you use peak search for the main response value of the two marker response values.

Bandwidth search

You perform the bandwidth search to determine the bandwidth of a trace. The bandwidth search also helps you to identify the following parameters associated with a stopband or passband based on the stimulus value of the active marker:

- The low and high frequencies (f_{low} and f_{high}) separated by the bandwidth
- The bandwidth of the trace, calculated as the difference between the high and low frequencies.
- The center frequency (f_{center}) from where the bandwidth is measured.
- The Q value (center frequency divided by the bandwidth)
- The insertion loss, specified by the position of the marker at the time you perform the search.

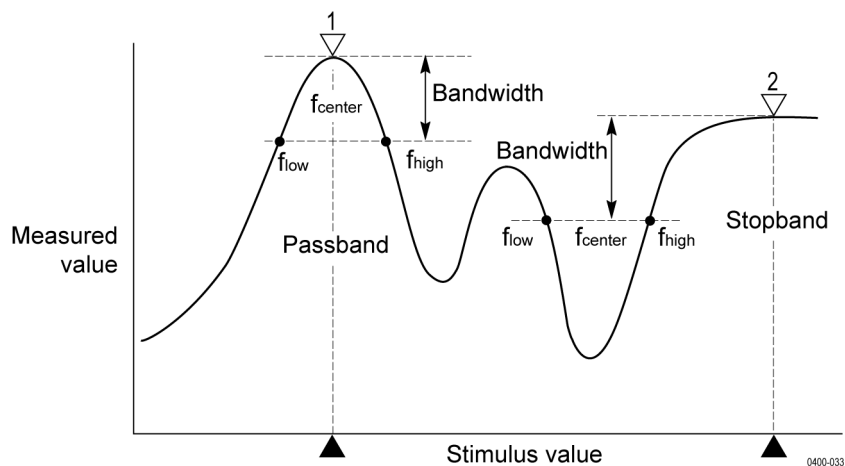

To perform a bandwidth search,

1. Place the marker at the desired stimulus value. The marker response value is the insertion loss.
2. In **Markers/Analysis > Search > More > Bandwidth Value**, enter a numeric value for the bandwidth.
3. Click the **Markers/Analysis > Search > Bandwidth** toggle button to enable the search.

The VNA displays high and low frequencies, the center frequency, bandwidth, insertion loss and Q value in the upper left corner of the channel display.

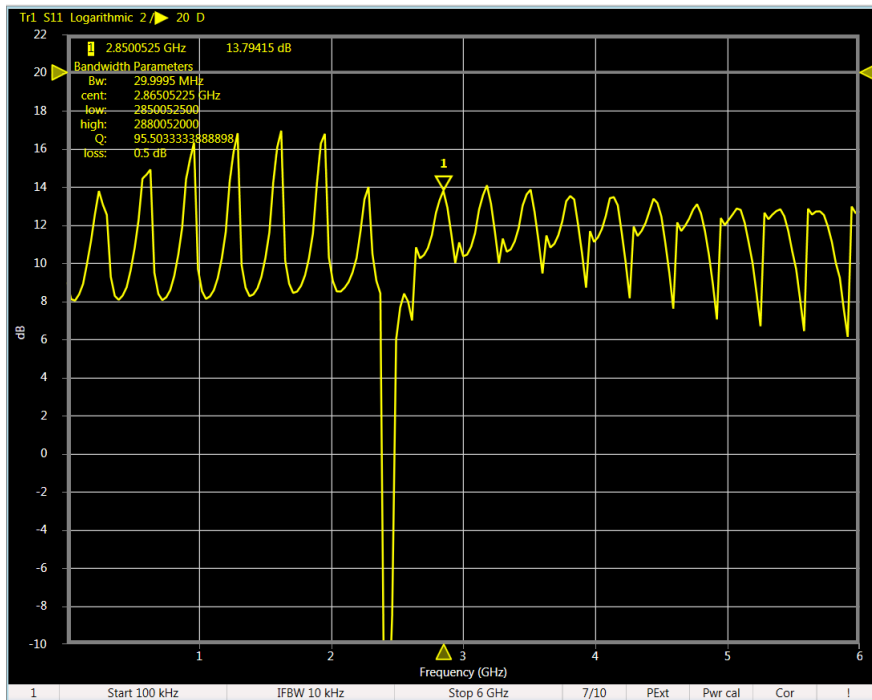

NOTE. The bandwidth search executes when you click the *Bandwidth* toggle button *ON*. If you have selected tracking, the bandwidth search always executes on a new trace.

Notch search for bandwidth

The notch search method is an alternative method to the bandwidth search that yields bandwidth parameters.

In the notch method, you specify a notch value to commence the search. The VNA begins the search on the left side of the marker position and completes the search when it locates a pair of points that are at the specified notch value. The frequencies obtained from those points are the lower and higher cutoff points. The notch search also displays the center frequency, bandwidth, Q value and insertion loss at the marker position.

To perform a notch search for the bandwidth of a trace,

1. Place the marker at the required measurement point. The marker response value is the insertion loss.
2. In **Markers/Analysis > Search > More > Notch Value**, enter a numeric value for the notch.
3. Click the **Markers/Analysis > Search > Notch** toggle button to enable the search.

The VNA displays lower and higher cutoff frequencies, the center frequency, bandwidth, insertion loss and Q value in the upper left corner of the trace.

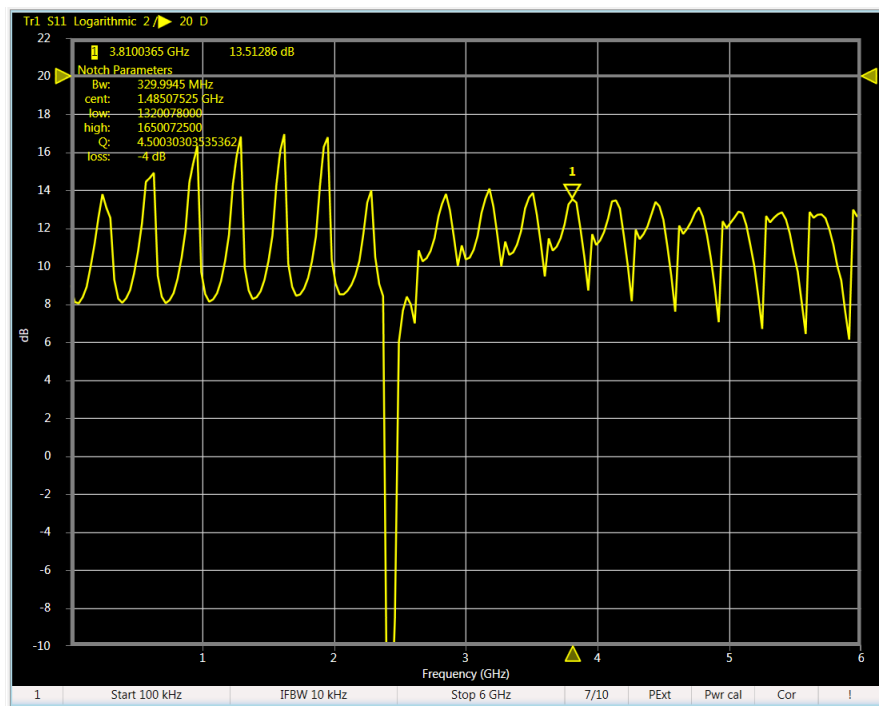

NOTE. The notch search executes when you click the Notch toggle button ON. If you have selected tracking, the notch search executes again for every new sweep.

See Also

- [Bandwidth search](#)
- [Peak search](#)

Trace data math operations

When you display a trace with measured data in VectorVu-PC, you can save a copy of the trace in the VNA as a memory trace. You do this by selecting the **Data** → **Mem** option in **Response** > **Display** > **Memory**. The memory trace is saved in the VNA until the next time you perform the operation, whereupon the memory trace is overwritten with the current data trace. Additionally, the memory trace is deleted if you change the number of points.

Use the memory trace to compare trace measurements with the data trace. You can also perform these math operations in **Response** > **Display** > **Memory** > **Data Math**. These math operations apply to every point on the data trace and its corresponding point on the memory trace.

Trace operations are done in the linear magnitude and phase format:

- A division of two quantities expressed as linear vectors is the equivalent of subtracting dBs and subtracting phase angles.
- A multiplications of two quantities expressed as linear vectors is the equivalent of adding dBs and adding phase angles.

Operation	Description
Data / Mem	Divide data trace by memory trace
Data * Mem	Multiply the data and memory traces.
Data - Mem	Subtract the memory trace from the data trace. Use this operation to deduct a measured error from the test data.
Data + Mem	Add the memory trace to the data trace.
Off	Turn off all data math operations.

To perform these math operations,

1. Set up a trace measurement.
2. Save the data trace to memory in **Display > Memory > Data → Mem**.
3. Display the data and memory traces. Select **Display > Memory > Display Content > Data & Mem**.

NOTE. When you select **Scale > Auto Scale**, the VNA scales the X and Y axes to display the data trace to scale. If the data and memory traces are near similar, you may not be able to see both of them clearly using the auto scale feature. Scale manually to zoom in and see the two traces. In cases where the data and memory traces are identical, you can display each trace separately by turning the other one off.

4. Select the mathematical operation you want to perform in **Display > Memory > Data Math**. The VNA performs the operation and modifies the display accordingly.
5. When you have finished your math operation, select **Display > Memory > Data Math > Off** to turn off data math. If necessary, you can save the trace using **System > Save/Recall > Save**.

NOTE. The math operations apply to the data trace only. You save the data trace to memory in order to reflect the changes in the memory trace. You can disable the display of the data trace but this does not disable the update to the trace as a result of the data math operation.

Normalize data

Normalizing is the process of performing a logarithmic division of every point on the data trace with its corresponding point on the memory trace. The **Normalize** feature automates the tasks of saving a memory trace and performing a Data/Mem operation. Use this feature when you need to perform these operations repetitively.

In the **Response** option group, select **Display > Memory > Normalize**.

See Also

- [Target search](#)
- [Bandwidth search](#)

Save VNA state

At any time when using the VNA, you can save the state of the instrument or recall a saved state. In the **System** option group, select **Save/Recall > Save** and the data type to save.

The VNA gives you options to save these types of data:

Data	Format	Description
State	*.state	Save VNA settings.
State+calibration	*.cstate	Save VNA settings and calibration data.
State+data	*.dstate	Save VNA settings and trace data.
State+calibration+data	*.cdstate	Save VNA settings, calibration information and trace data.

Save and recall trace/channel

- To save all channels and traces, select **Save/Recall > Save**.
- When you save all channels and traces, use **Save/Recall > Recall** to recall this information and select **All state files(*.*state)** when browsing in the file browser.

See Also

- [Recall saved data](#)
- [Save touchstone \(SnP\) files](#)

Recall saved data

You can retrieve saved data in the VNA when the information is in one of these formats:

- State (*.state)
- State+calibration (*.cstate)
- State+data (*.dstate)
- State+calibration+data (*.cdstate)
- All state files (*.state)

Limitations when recalling data

- You can only retrieve measurement data saved using a TTR500 series instrument. You cannot retrieve information saved using a network analyzer from another vendor.
- Calibration and state information are unique to an individual VNA at a particular time and in a specific environment. You cannot share calibration data (*.cstate files) between different TTR500 series instruments.
- The data saved in a VNA is specific to the environment of the instrument. When you recall the saved state of an instrument (*.state or *.dstate file) and reinstate these settings, the VNA can behave differently if the operating conditions have changed from the time the information was saved.

See Also

- [Save VNA state](#)
- [Save touchstone \(SnP\) files](#)

Save touchstone (SnP) files

You can save s-parameter information from the VNA for 1–port and 2–port models in the touchstone format. Touchstone files contain S-parameters of the DUT in a space-separated format. The number of ports used in the measurement determines the matrix of S-parameters for the DUT and consequently, the format of the touchstone file.

For example, a 2–port model results in the measurement of 4 S-parameters in a 2x2 matrix: $[S_{11} S_{12} S_{21} S_{22}]$. The corresponding touchstone file that contains these S-parameters is an S2P file.

The TTR500 series VNAs support S1P and S2P formats for 1–port and 2–port models respectively. The S-parameters are recorded as complex numbers that indicate:

- Linear magnitude+angle (dB)
- Logarithmic magnitude+angle (MA)
- Real+imaginary (RI)

In a touchstone file, the behavior of the DUT is completely represented by the collection of its S-parameters. You can import the touchstone file into a data modeling program or circuit simulator like MATLAB or Keysight Advanced Design System (ADS). Use the S-parameter representation of the DUT when you build and simulate models in these programs.

1. For the active trace, in the **System** option group, specify the representation of the S-parameter complex form in **Save/Recall > Save SnP > SnP Format**. When you select **Auto**, the VNA retains the default format in which S-parameters are recorded on the trace.
2. Select the format of the touchstone file (S1P or S2P). For an S1P file, select the port at which you are measuring the DUT.
3. Save the touchstone file.

NOTE. When you save data to a touchstone file in the sweep mode, the VNA saves data from the previous sweep in the touchstone file. If a sweep operation has not occurred by the time you save data, no information gets stored in the touchstone file. For this reason, set the active channel to **Hold** when saving data in sweep mode in a touchstone file.

S1P files

An S1P file represents S-parameters for a 1–port measurement. The header contains information obtained in response to the *IDN? query. The data portion of the file contains a list of frequencies along with corresponding S_{11} or S_{22} values (in complex format), depending on the port used for measurements.

```
! TTR506A,Tektronix inc.,Y010080,Application version 0.8.3.dea5088b Firmware version FW000001
!
! Freq ReS11 ImS11
# Hz S RI R 50
100000 2.191346 -0.43378679
30099500 1.5597287 -0.41248082
60099000 1.4010042 -0.7824603
90098500 1.1553102 -1.1033061
1.20098e+08 0.83835353 -1.3529321
1.500975e+08 0.47044996 -1.5202507
1.80097e+08 0.069062846 -1.5805
2.100965e+08 -0.012198783 1.1233457
2.40096e+08 0.27645425 1.1022999
2.700955e+08 0.54634338 0.9940016
3.00095e+08 0.77793592 0.8195733
3.300945e+08 0.95683653 0.5910899
3.60094e+08 1.0718847 0.3250598
3.900935e+08 1.1128624 0.037021746
4.20093e+08 1.0808404 -0.25197774
4.500925e+08 0.97244977 -0.52174142
4.80092e+08 0.79667918 -0.75308644
5.100915e+08 0.56529822 -0.9274576
5.40091e+08 0.29874994 -1.0337036
5.700905e+08 0.018592219 -1.0630267
6.0009e+08 -0.2534642 -1.0195774
6.300895e+08 -0.49856438 -0.90710845
6.60089e+08 -0.70362756 -0.74481155
6.900885e+08 -0.85951301 -0.5424385
7.20088e+08 -0.96491684 -0.31383103
7.500875e+08 -1.0096228 -0.070330862
7.80087e+08 -1.0019943 0.17714827
8.100865e+08 -0.93869723 0.41958084
8.40086e+08 -0.82095539 0.64341489
8.700855e+08 -0.64992038 0.84183618
9.00085e+08 -0.43201837 0.99824206
9.300845e+08 -0.17151948 1.1009049
9.60084e+08 0.11869094 1.1346528
9.900835e+08 0.41606329 1.0913788
1.020083e+09 0.70254342 0.96497514
1.0500825e+09 0.95233062 0.76098463
1.080082e+09 1.1383633 0.48761525
1.1100815e+09 1.2437315 0.16535559
1.140081e+09 1.2517536 -0.17756509
1.1700805e+09 1.1613687 -0.51046521
1.20008e+09 0.97971164 -0.80196606
1.2300795e+09 0.7253416 -1.0257757
1.260079e+09 0.4236982 -1.1636779
1.2900785e+09 0.10586089 -1.2165326
```

S2P files

An S2P file represents S-parameters for a 2–port measurement. The header contains information obtained in response to the *IDN? query. The data portion of the file contains a list of frequencies along with the matrix of S-parameters for a 2–port device (S_{11} , S_{12} , S_{21} , and S_{22}). The S-parameters are in complex format, depending on the port used for measurements.

```

! TTR506A,Tektronix inc.,Y010035,Application version 0.8.5.e98e6574 Firmware version FW000001
!
! Freq ReS11 ImS11 ReS21 ImS21 ReS12 ImS12 ReS22 ImS22
# Hz S RI R 50
1.e+08 -0.88134299 0.41131586 -0.00020497254 8.1289492e-05 -0.00015339653 6.281492e-05 0.97815482 -0.21887555
1.2e+08 -0.84168298 0.48305042 -0.00019281752 8.2453511e-05 -0.00028159097 0.00014733778 0.96955561 -0.26070847
1.4e+08 -0.79594163 0.55059175 -0.00032388943 0.00017145596 -0.00039967446 0.00018842988 0.95781634 -0.30213987
1.6e+08 -0.74512816 0.61537548 -0.00041263159 0.00026617078 -0.00048011616 0.0003074561 0.94336505 -0.34172828
1.8e+08 -0.6899571 0.67371642 -0.00051047453 0.00035026116 -0.00052384155 0.00041164302 0.92887159 -0.38054155
2.e+08 -0.63681774 0.73567049 -0.00080769832 0.00074102039 -0.00081221331 0.00078985298 0.91473918 -0.41972889
2.2e+08 -0.57329061 0.78560207 -0.00093489385 0.00084722877 -0.00076796533 0.00086006754 0.89594187 -0.45672246
2.4e+08 -0.50344563 0.82739514 -0.0011347078 0.0010742602 -0.000897067 0.00096411434 0.87696432 -0.49320964
2.6e+08 -0.43025095 0.86674842 -0.0011825868 0.0010799102 -0.0010033134 0.0014316853 0.85520509 -0.52703866
2.8e+08 -0.3567496 0.89808751 -0.0011680133 0.0013159754 -0.00096820516 0.0014794815 0.83387279 -0.56032604
3.e+08 -0.27989569 0.92442836 -0.0012266248 0.0016506644 -0.001351898 0.0017439059 0.81296603 -0.59146519
3.2e+08 -0.20051205 0.94469901 -0.001199008 0.0017927959 -0.00099952156 0.0018770198 0.79170195 -0.62215476
3.4e+08 -0.12091698 0.95525793 -0.0010182971 0.0023128893 -0.0011234843 0.0023488068 0.76847296 -0.65083654
3.6e+08 -0.039369304 0.96246819 -0.00092932757 0.0026540023 -0.0012178049 0.0027891754 0.74587843 -0.67633443
3.8e+08 0.041131932 0.96286509 -0.00085474798 0.0027463171 -0.00099380514 0.0027234156 0.72268772 -0.70214295
4.e+08 0.1231488 0.95439704 -0.00039571096 0.0033293369 -0.0011549286 0.003034774 0.69697015 -0.72596813
4.2e+08 0.20282299 0.94022564 -0.00066261264 0.0033397091 -0.00070123952 0.0031631645 0.67166985 -0.74893686
4.4e+08 0.2817167 0.91833774 -0.00068604974 0.003931378 -0.00064941017 0.0036585629 0.64611463 -0.77073033
4.6e+08 0.35878357 0.89195094 -0.00068052893 0.0042963412 -0.00045699667 0.0038316473 0.61970606 -0.79049943
4.8e+08 0.43287912 0.85868437 -0.0005902052 0.0046389458 -0.00036290471 0.0040856326 0.59540113 -0.81017674
5.e+08 0.50343272 0.81868422 -0.0003833562 0.0045757918 2.2291715e-05 0.0042751633 0.57181241 -0.82858887
5.2e+08 0.57122244 0.7719272 0.00028308343 0.0044923263 5.6994586e-05 0.0046626691 0.54777976 -0.84478402
5.4e+08 0.63654332 0.72058221 0.00059128889 0.0044437048 0.00028928254 0.0046090198 0.52398615 -0.86033188
5.6e+08 0.69481075 0.66313162 0.00048644592 0.0047786781 0.0006810053 0.0047275744 0.50020516 -0.87288273

```

See Also

- [Save VNA state](#)
- [Recall saved data](#)

Expand dynamic range

The noise floor of the VNA is the minimum power level at which you measure with the VNA. The span from the noise floor to the maximum input power level is called the dynamic range of the VNA. When you need to evaluate large amplitude spans, it is useful to expand the dynamic range. You do this by lowering the noise floor.

To lower the noise floor, you can:

- Narrow the IF bandwidth
- Enable sweep averaging

Narrow the IF bandwidth

When you lower the IF bandwidth, you reduce the effect of extraneous noise on the measurement. To change the IF bandwidth, click **Response > Avg > IF Bandwidth** and enter a new value.

Enable sweep averaging

When you perform sweep averaging, you calculate the data average of every vector point on the sweep, based on the exponential average of a continuous sweep. The exponential average is weighted by an averaging factor that you specify.

For any point that is a vector quantity, the sweep averaging (A_n) for the nth sweep operation at that point is:

$$\left(\frac{S_n}{F}\right) + \left(\frac{n-1}{F}\right)(A_{n-1})$$

Here S_n is the measurement value at the n th sweep operation at that measurement point. F is the sweep averaging factor, ranging from 1 to 999.

For the active channel,

1. In **Response > Avg**, click **Averaging** and enable the feature.
2. Click **Factor** and enter a value between 1 and 999.

Click **Restart** to reset the value of n to 1 in the sweep averaging equation.

See Also

- [Improve phase measurement accuracy](#)
- [Improve measurement throughput](#)

Improve phase measurement accuracy

Use these settings to improve the accuracy of phase measurements using the VNA.

- [Electrical delay](#)
- [Phase offset](#)
- [Apply port extensions](#)

Electrical delay

Electrical delay is a mathematical function that introduces a phase shift, similar to transmission through a lossless delay line. You can use this function to examine the deviation of a phase measurement or Smith chart measurement from a linear phase response.

You can specify the electrical delay for each trace. Depending on the type of medium (coaxial or waveguide), the calculation of the electrical delay varies.

For the active trace,

1. In **Response > Scale > More**, select **Electrical Delay**. A dialog box opens.
2. Enter the delay value as a length of lossless transmission line (m) or a measure of time (seconds).
3. Specify a velocity factor. Typical values are:

Medium	Velocity Factor
Polyethylene dielectric cable	0.66
PTFE Dielectric	0.7

Medium	Velocity Factor
Foamed polyethylene dielectric	0.82
Light in vacuum	1

4. Select the medium of the delay line. For a waveguide medium, you must also specify the cutoff frequency.

Phase offset

When you know the amount of phase adjustment to include in a measurement, use the phase offset feature to make the correction. This option allows you to include a predetermined value to the frequency to account, for example, the addition of a cable.

In **Scale > Phase Offset**, specify a phase offset value between -360° to $+360^\circ$.

See Also

- [Expand dynamic range](#)
- [Improve measurement throughput](#)

Improve measurement throughput

Use these settings in the VNA to improve the measurement throughput:

- [Switch off information update](#)
- [Switch off error correction](#)

Switch off information update

Each time you make a measurement, VectorVu-PC and the VNA consume additional time to update graph displays dynamically. When you do not need to inspect measurements and changes in the display graph at the time you make the measurements, switch off dynamic updates in the software.

In the **Display** option group, click the **Update** button to toggle the setting off. The Instrument Status bar indicates 'Update off'.

Disable factory error correction

The VNA uses factory calibration data to implement a factory error correction to your measurements. This factory correction is available if you do not want to calibrate the VNA in a specific configuration. The factory correction is not required if you perform:

- VNA calibration procedures for S-parameters as described in this manual.
- Power calibration
- Receiver calibration

Proper calibration of the VNA automatically turns on an error correction that supersedes the factory correction. Measurement accuracy improves when you enable the error correction by calibrating the VNA. To improve your measurement throughput, switch off the factory correction.

In **System > More > System Correction**, click the **System Correction** button to toggle the setting off.

System option group

The **System** option group contains several settings and features to help you customize the operation of your VNA:

- [Save/Recall](#)
- [Preset](#)
- [Language](#)

In **System > More**, you can set these additional options:

- [Bias Tee](#)
- [Reference Clock Source](#)
- [Beep](#)
- [System Correction](#)
- [Connections](#)
- [Simulator](#)
- [Log Severity](#)
- [OPC Logger](#)

Save/Recall

Use the options in this set to save channel and trace information to your system.

See Also:

- [Save VNA state](#)
- [System option group](#)

Preset

Use **System** > **Preset** to restore the state of the VNA to factory settings.

See Also:

- [System option group](#)
- [Default settings for System options](#)

Language

You can configure the user interface of VectorVu-PC dynamically in any of these languages:

- English
- Japanese
- Korean
- Vietnamese
- Chinese
- Taiwanese Mandarin

See Also:

- [System option group](#)
- [Default settings for System options](#)

More options

Toggle these options to set or clear them in the VNA by clicking the respective buttons. You can see the current setting in the Data Entry bar.

Option	Description	Settings
Bias Tee	Enable bias tee function.	On/Off
Reference Clock Source	Set the reference clock source	Internal / External
Beep	Test and use a beep alert for system actions	<ul style="list-style-type: none"> ■ Beep Warning – beep when the VNA displays a warning ■ Test Beep Warning – test the Beep Warning function
System Correction	Apply factory error correction (Enable/disable factory error correction function)	On / Off

See Also:

- [Connections](#)
- [Default settings for System options](#)
- [System option group](#)

Connections

The Connection Manager window displays the instruments that VectorVu-PC can detect. These are:

- TTR500 series VNAs connected to your system
- Internal simulator available in VectorVu-PC. This is a software application that allows you to operate VectorVu-PC without an instrument connection.

For each device, you can see these details:

- Model number of the VNA unit
- Firmware version of the VNA
- Connection status of the instrument
- Software version of VectorVu-PC simulator

Use Connection Manager

Use Connection Manager to pair TTR500 series VNAs with one or more instances of VectorVu-PC. When you connect a TTR500 series VNA to your Windows machine, the system recognizes and copies over driver files from the VNA device. Connection Manager uses these files to identify the VNA.

1. Open Connection Manager in **System > More > Connections**. In the display window, you see a list of VNA devices associated with the current instance of VectorVu-PC. This list includes current VNA connections as well as units connected previously. The list also includes the simulator internal to the software.
2. Select the VNA device that is currently connected to your machine. If you have multiple units connected to your machine, the unit that is controlled by VectorVu-PC displays as **‘Connected’**. To operate in simulation mode, select **simulator**.

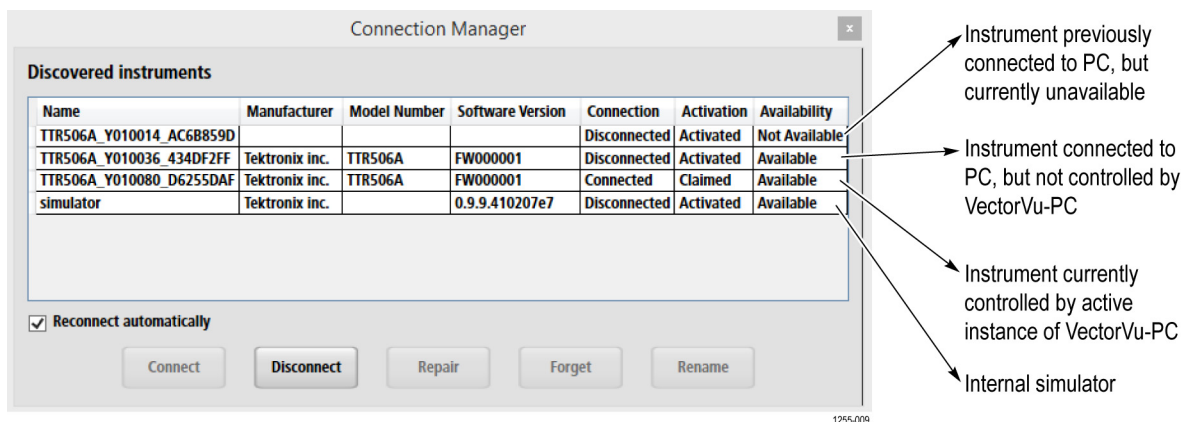

This table explains the various states of VNA connections:

Connection information	States	Description
Connection	Connected	The active instance of VectorVu-PC currently controls the VNA.
	Disconnected	The active instance of VectorVu-PC does not control the VNA. (default for new connection)
Activation	Not Activated	VectorVu-PC has not copied the calibration files of the VNA. (default for new connection)
	Activated	VectorVu-PC has copied the calibration files of the VNA from the non-volatile instrument memory to PC.
	Claimed	An instance of VectorVu-PC controls the selected VNA. If a VNA is connected to an instance of VectorVu-PC, the instrument appears as 'claimed' in other instances of the software.
Availability	Not Available	VNA is not currently connected to the computer via USB.
	Available	VNA is communicating with the computer via USB

3. If you are connecting the VNA to your computer for the first time, click **Connect**. VectorVu-PC copies the calibration files of the VNA and activates the VNA.

Once you connect a VNA to an instance of VectorVu-PC, that instance of the software ‘claims’ the VNA. Thereafter, the device appears as ‘claimed’ in other instances of VectorVu-PC.

4. Check **Reconnect automatically**. VectorVu-PC connects to the VNA the next time you enable a USB connection. You can change the active connection in Connection Manager at any time.

NOTE. *You can see the name of the active connection in the title bar as well as the tool tip of the instrument connection icon in the Instrument Status bar.*

See Also

- [System options](#)
- [Simulator](#)

Simulator

VectorVu-PC has an internal VNA simulator that you can use for analysis without a TTR500 unit. Use Connection Manager to switch to simulator mode. When you connect the simulator, the Instrument Status bar turns gray. This is because the information in the Instrument Status bar only applies to measurements made using TTR500 units.

Click **System > More > Simulator** to open the simulator submenu. These options are available:

Load SnP

When you use the internal simulator in VectorVu-PC, use the **Load SnP** function to load data in the SnP (Touchstone) format for offline analyses. The SnP file completely represents the S-parameters of a DUT.

When you use the SnP file of a DUT in the offline (simulator) mode:

- You do not need the actual DUT for analysis. Therefore, you can share parameter data with other users.
- You do not need to be at the test location to analyze the data.

Noise Floor

Set the noise floor level for your measurements using the **Noise Floor** function. The noise floor is the sum of all noise sources and unwanted signals in the VNA. It limits the smallest measurement that can be isolated from the noise. Ideally, a lower noise floor is better for more accurate measurements.

See Also

- [System options](#)
- [Connections](#)

Log severity and OPC logger

If you notice a problem in the performance of your VNA that indicates a service issue, use the log severity and OPC logger options to create and send log files to Tektronix. These settings allow you to change the type of information that the device logs. Use these options in combination to log the performance of the VNA.

When you need to debug errors in the performance of the VNA:

1. Change the default settings for these options in **System > More**.

Option	Default setting	Change to..
Log Severity	Warning	Debug
OPC Logger	OFF	ON

2. When the error occurs again, OPC logger records this information in the log files. Send the log files to a Tektronix service professional to further investigate the problem.

See Also

- [System options](#)
- [Connections](#)

Stimulus options

Parameter / Setting	Location	Description	Default value	Scope
Start frequency	Start	Start frequency of sweep	300 kHz	Channel
Stop frequency	Stop	Stop frequency of sweep	6 GHz	Channel
Center frequency	Center	Center frequency of sweep	3.0015 GHz	Channel
Span frequency	Span	Frequency span of sweep	5.9997 GHz	Channel
Power level	Sweep Setup > Power Menu > Power Level	Set output power level	0 dBm	Channel
Port couple	Sweep Setup > Power Menu > Port Couple	Apply same/different power settings on both ports	YES (same power settings)	Channel
Port power	Sweep Setup > Power Menu > Port Power	Power settings per port	0 dBm	Channel
Slope value	Sweep Setup > Power Menu > Slope Value	Enter dB/GHz change from start to stop	0 dB/GHz	Channel
Power slope	Sweep Setup > Power Menu > Slope	Enable/disable power slope	NO (disable power slope)	Channel
RF output	Sweep Setup > Power Menu > RF Out	Enable/disable RF output	NO (disable RF output)	Channel
Auto sweep time	Sweep Setup > Auto Sweep Time	Enable/disable auto sweep time	NO (disable auto sweep)	Channel
Sweep time	Sweep Setup > Sweep Time	Set sweep time	20.301 ms	Channel
Sweep delay	Sweep Setup > Sweep Delay	Set delay to sweep.	0 sec	Channel
Points	Sweep Setup > Points	Set frequency points in sweep	201	Channel
Sweep type	Sweep Setup > Sweep Type	Set type of sweep	Linear frequency	Channel
Avoid spurious	Sweep Setup > Avoid Spurious	Avoid spurious	YES NOTE. The default setting changes to NO in simulator mode.	Channel

Parameter / Setting	Location	Description	Default value	Scope
Trigger source	Trigger > Trigger Source	Select the trigger source	Internal	Channel
Point trigger	Trigger > Point Trigger	Enable/disable a point measurement at every trigger	NO (disable point trigger)	Channel

See Also

- [Channel / Trace options](#)
- [Response options](#)
- [Markers / Analysis options](#)
- [System options](#)

Channel/Trace options

Parameter / Setting	Location	Description	Default value	Scope
Active channel	Channel > Active	Select active channel	1	Channel
Number of channels	Channel > Num Channels	Select number of channels	1	Channel
Active trace	Trace > Active	Select active trace number	1	Trace
Number of traces	Trace > Num Traces	Select number of traces per channel	1	Trace
Active window	Window > Active	Select active window	1	Channel
Channel layout	Channel > Channel Layout	Set channel layout.	D1	Channel

See Also

- [Stimulus options](#)
- [Response options](#)
- [Markers / Analysis options](#)
- [System options](#)

Response options

Parameter / Setting	Location	Description	Default value	Scope
Format	Format	Select format to display data	Log Mag	Channel
Phase units	Format > More > Phase Units	Select unit of phase	Degrees	Channel
Divisions	Scale > Divisions	Select number of vertical divisions on graph	16	Channel
Scale per division	Scale > Scale/Div	Select number of units per vertical division	10 dB	Channel
Reference position	Scale > Reference Position	Select reference position on graph	15	Channel
Reference value	Scale > Reference Value	Select measurement value at reference position	0 dB	Channel
Electrical delay	Scale > More > Electrical Delay	Mathematically correct for an electrical delay in measurement	0 s	Trace
Phase offset	Scale > More > Phase Offset	Mathematically correct for a phase offset in measurement	0 degrees	Trace
Title label	Display > Labels > Display Title Label	Display title label	YES	Trace
Graticule label	Display > Labels > Graticule Label	Display graticule label	YES	Trace
Frequency label	Display > Labels > Frequency Label	Show/hide frequency label	YES	Trace
Invert color	Display > Invert Color	Invert trace and background colors	Normal	Trace
Graph update	Display > Update	Turn ON/OFF measurement graph update	YES (turn ON update)	Analyzer
Menu bar	Display > Menu Bar > Display Menu Bar	Show/hide menu bar	YES (show menu bar)	Analyzer
Bar font	Display > Menu Bar > Bar Font	Select menu bar font size	14	Analyzer
Averaging factor	Avg > Factor	Select number of traces to average	16	Channel
Averaging	Avg > Averaging	Enable/disable averaging	NO (disable averaging)	Channel

Parameter / Setting	Location	Description	Default value	Scope
Averaging trigger	Avg > Avg Trigger	Perform <Averaging factor> sweeps / 1 sweep following trigger	NO	Channel
Smoothing aperture	Avg > Smoothing Aperture	Select moving average of frequency points	1.5	Channel
Trace smoothing	Avg > Enable Smoothing	Enable/disable trace smoothing	NO	Channel
IF Bandwidth	Avg > IF Bandwidth	Set intermediate frequency bandwidth	10 kHz	Channel
Error correction	Cal > Correction	Enable/disable error correction	NO	Channel
Calibration trigger source	Cal > More > Cal Trig Source	Select calibration trigger source	Internal	Channel

See Also

- [Stimulus options](#)
- [Channel / Trace options](#)
- [Markers / Analysis options](#)
- [System options](#)

Markers/Analysis options

Parameter / Setting	Location	Description	Default value	Scope
Reference marker	Setup > More > Ref Marker	Select reference marker	3 GHz	Channel
Peak excursion	Search > Peak > Peak Excursion	Define peak excursion to find next peak	3 dB	Channel
Peak polarity	Search > Peak > Peak Polarity	Select peak polarity	Positive	Channel
Target value	Search > Target > Target Value	Enter target value	0 dB	Channel
Target transition	Search > Target > Target Transition	Select transition type	BOTH	Channel
Search range	Search > Search Range	Define search range	Entire sweep range	Channel
Bandwidth search	Search > Bandwidth	Enable/disable bandwidth search	NO (disable bandwidth search)	Channel
Bandwidth value	Search > More > Bandwidth Value	Specify loss for bandwidth search	3 dB	Channel
Notch search	Search > More > Notch	Enable/disable notch search	NO (disable notch search)	Channel
Notch search value	Search > More > Notch Value	Specify notch search value	-3 dBm	Channel
Couple traces	Function > Couple	Couple/decouple traces for marker action	YES (couple traces)	Channel
Discrete mode	Function > Discrete	Set display mode for marker to discrete mode	Discrete	Channel

See Also

- [Stimulus options](#)
- [Channel / Trace options](#)
- [Response options](#)
- [System options](#)

System options

Parameter / Setting	Location	Description	Default value	Scope
Save data	Save / Recall > Save	Save state, calibration, state data	*.cstate	Analyzer
Recall data	Save / Recall > Recall	Recall state, calibration, state data	*.cstate	Analyzer
SnP format	Save / Recall > Save SnP > SnP Format	Select format for Touchstone file	Real + Imaginary	Analyzer
Bias Tee	More > Bias Tee	Enable/disable bias tee	Disabled	Analyzer
Reference clock source	More > Reference Clock Source	Select internal/external reference clock	Internal	Analyzer
Beep warning	More > Beep > Beep Warning	Beep when warning	YES	Analyzer
System correction	More > System Correction	Enable/disable system correction	YES (enable system correction)	Analyzer
Noise floor	More > Simulator > Noise Floor	Insert additive noise	-150 dBm/Hz	Analyzer
Log severity	More > Log Severity	Control on logging severity	Warning	Analyzer
OPC logger	More > OPC Logger	Enable/disable OPC logger	NO disable OPC logger)	Analyzer

See Also

- [Stimulus options](#)
- [Channel / Trace options](#)
- [Response options](#)
- [Markers / Analysis options](#)

Frequency response of a band pass filter

Suppose you want to measure the frequency response of a band pass filter. This is a 3-part procedure:

- Calibrate the VNA
- Set up the band pass filter
- Measure frequency response

Calibrate the VNA

1. Select a calibration kit. You can use one of the standard kits preloaded in VectorVu-PC or create a kit of your choice.
2. Calibrate the VNA. For the purpose of this measurement, you perform the 2-port 2-path SOLT (Full two-port) calibration.

See Also:

- [Select a calibration kit](#)
- [Add/Modify a calibration kit](#)
- [2-port 2-path SOLT \(Full Two Port\) calibration](#)

Set up the band pass filter

1. Connect the male terminal of the filter to port 1 of the VNA using an adapter cable. You may need to use a male-male adapter for this purpose.
2. Connect the female terminal of the filter to port 2 of the VNA using an adapter cable.

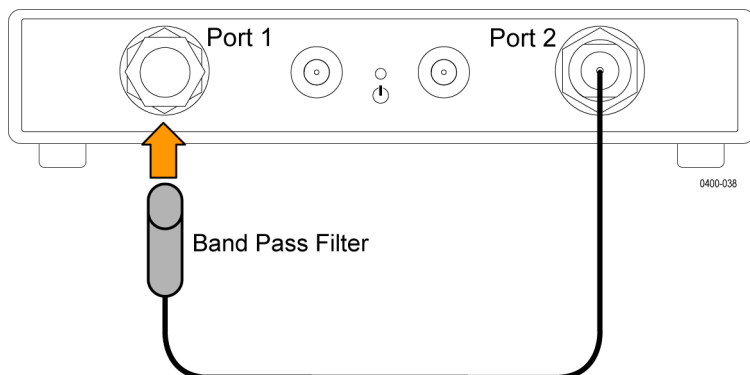

3. In VectorVu-PC, set these parameters. The values below apply for the band pass filter used in this example. Select appropriate values based on the characteristics of the filter you use.

Parameter	Location	Setting
Start frequency	Stimulus > Start	500 MHz
Stop frequency	Stimulus > Stop	2.5 GHz
IF Bandwidth	Response > Avg > IF Bandwidth	100 Hz
Power	Stimulus > Sweep Setup > Power Menu > Power Level	0 dB
Points	Stimulus > Sweep Setup > Power Menu > Points	201

Record S-parameters

1. Set up traces to measure the S-parameters of the filter. In **Channel/Trace > Trace > Num Traces**, select 4 traces. The traces are labeled Tr1–Tr4 and they appear in different colors in the active channel.
2. Click on trace Tr1 to make it active. Use this to measure S_{11} .
3. In **Response > Measure**, click S_{11} . The VNA records the S_{11} measurement in Tr1.
4. Repeat steps 2 and 3 for the other S-parameters. The active channel displays all 4 traces.
5. To view the traces in separate windows, in **Channel / Trace > Trace > Trace Layout**, select a configuration for four traces.

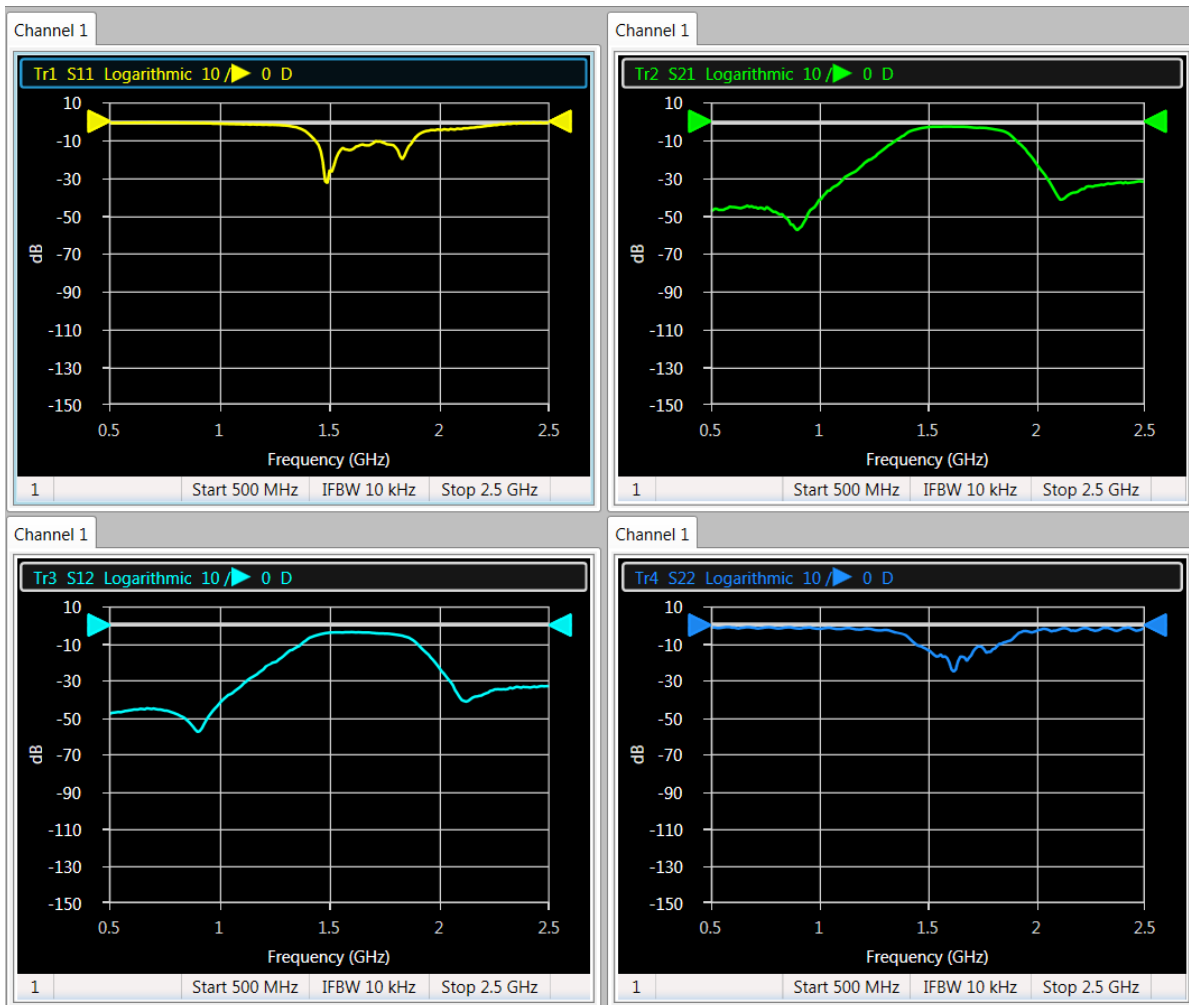

6. If you need to adjust the scale for any of the traces, use **Response > Scale > Auto Scale**. Use the **Auto Scale All** option to adjust the scales of all of the traces simultaneously.

Bandwidth search

1. Select the S_{21} trace.
2. In **Markers / Analysis > Setup**, select **Marker 1** and set it to 1.5 GHz.
3. To perform the bandwidth search, select **Markers / Analysis > Search > Bandwidth**.
4. In **Markers / Analysis > Search > More > Bandwidth Value**, specify 3 dB.

The VNA displays these bandwidth parameters in the upper left corner of the graph:

- Bandwidth
- Center frequency
- Lower cutoff frequency

- Higher cutoff frequency
- Q value
- Insertion loss

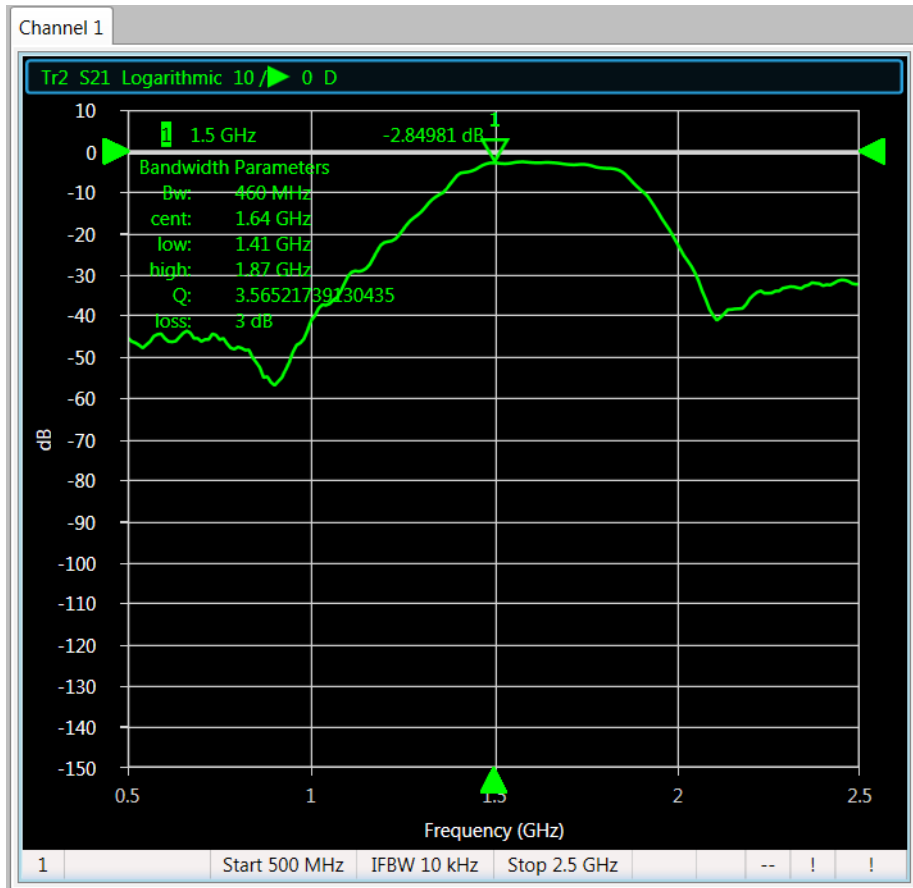

See Also

- [Use touchstone SnP files for offline analysis](#)

Use touchstone (SnP) files for offline analysis

In this example, you save and recall S-parameter data for a device using touchstone (SnP) files. When you save device information in an SnP file, you can use the file to perform analysis offline and away from the test setup. Also, you do not require the device for analysis as long as the SnP file contains all the S-parameter information.

Save an S2P file

1. Calibrate the VNA following the [2–port 1–path SOLT Enhanced Response calibration](#) procedure.
2. Set up four traces (Tr1–Tr4). Measure all four S-parameters.
3. In **System > Save / Recall > Save SnP**, select **S2p**.
4. After saving the file, go to the saved location and open the file using a text editor. Observe the information stored in the file.

```

! TTR500A,Tektronix Inc.,W10035,Application version 0.8.5.4984574 Firmware version F0000001
!
! Freq ReS11 InS11 ReS21 InS21 ReS12 InS12 ReS22 InS22
# Hz S R1 R  S
1.4e+00 -0.00184209 0.41211306 -0.0000007724 0.1209010e-05 -0.0001533903 0.2018030e-05 0.07815062 -0.21087355
1.2e+00 -0.84568208 0.48305042 -0.0001201752 0.2453511e-05 -0.0002015907 0.0001473778 0.96955561 -0.26078647
1.4e+00 -0.79594163 0.5569175 -0.0001208943 0.0001714559 0.0001399746 0.0001884288 0.95781634 -0.30213987
1.6e+00 -0.74512016 0.61573748 -0.0001213159 0.0001661307 -0.0004001516 0.0001897454 0.94315095 -0.34172928
1.8e+00 -0.68999571 0.67171642 -0.0001847453 0.0001504616 0.0001238415 0.0001164382 0.92887159 -0.38854155
2e+00 -0.63081714 0.71678069 -0.0000709632 -0.0001410019 -0.0001221313 0.0001995298 0.91471918 -0.43778809
2.2e+00 -0.57129061 0.75602027 -0.0001481935 0.0004722877 -0.0007676533 0.0000608754 0.89541817 -0.45672246
2.4e+00 -0.50444563 0.82779154 -0.0011247078 0.0018742002 -0.00007007 0.0009441244 0.87896432 -0.49209964
2.6e+00 -0.43025095 0.86474642 -0.0011825068 0.0018791812 -0.0018011114 0.0014116053 0.85529089 -0.52703866
2.8e+00 -0.3567406 0.89808751 -0.0011680133 0.0021319754 -0.0009682016 0.0014794815 0.83387279 -0.56032048
3e+00 -0.27399569 0.92482836 -0.0012262408 0.0016586644 -0.00131098 0.0017430959 0.81296603 -0.59146519
3.2e+00 -0.20051205 0.94469981 -0.001199008 0.0017927959 -0.0009952156 0.0018778198 0.79178195 -0.62154746
3.4e+00 -0.12091088 0.95525793 -0.0018182971 0.0023128893 -0.0011274843 0.0021488968 0.76847296 -0.65083054
3.6e+00 -0.03916984 0.96266619 -0.00092912757 0.0026508021 -0.0012278069 0.0007891744 0.74587843 -0.67613443
3.8e+00 0.041131932 0.96286589 -0.00085474798 0.0027463171 -0.0009938814 0.0027241156 0.72268772 -0.70214295
4e+00 0.1131488 0.94819764 -0.0001957896 0.003105306 0.0001540206 0.000484774 0.69697015 -0.72506813
4.2e+00 0.20182299 0.94021544 -0.0006261264 0.003397891 -0.0007812392 0.0011611645 0.67169885 -0.74891686
4.4e+00 0.2817167 0.91833714 -0.0006040974 0.003931378 -0.0006401017 0.0015050529 0.64614863 -0.77073033
4.6e+00 0.35878357 0.89295064 -0.000802893 0.0042963412 -0.0004599667 0.0018316473 0.61978606 -0.79049943
4.8e+00 0.43287912 0.85868437 -0.0001590252 0.0046394658 -0.0001629047 0.000495126 0.59540113 -0.81071714
5e+00 0.50143272 0.81804022 -0.000183562 0.004677791 2.1201171e-05 0.0004751633 0.57181261 -0.83058887
5.2e+00 0.57122244 0.77159272 0.0001838343 0.0044923263 5.694580e-05 0.0046626091 0.54777976 0.84478482
5.4e+00 0.63654213 0.72058211 -0.0009120889 0.0044417048 0.0001892054 -0.004409188 0.52398615 -0.86011188
5.6e+00 0.69481875 0.66311162 0.00048644592 0.004778781 0.0006318053 0.0047275744 0.50020516 -0.87288273
    
```

Notice that the S-parameters are stored in the complex form in an S2P file. Next, you recall the S-parameter information stored in this file.

Recall an S2P file

Recall the saved S2P file in the simulator mode in VectorVu-PC to use it offline.

1. Open the Connection Manager in **System > More > Connections**.
2. Connect VectorVu-PC to the internal simulator.
3. In **System > More > Simulator**, select **Load SnP**.
4. Import the S2P file saved in step 3 in [Save an S2P file](#).
5. Verify the S-parameter information contained in the S2P file. In **Response > Measure**, select any S-parameter and the graph should populate with the corresponding trace, reading data from the S2P file you recalled.

See Also

- [Frequency response of a band pass filter](#)

How the VNA operates

The TTR500 series VNAs operate over frequency ranges of 100 kHz – 3 GHz (TTR503A) and 100 kHz – 6 GHz (TTR506A). The VNA measures RF and microwave electronic components by:

- Providing a stimulus signal that is stepped over a range of measurement frequencies.
- Receiving these signals:
 - stimulus signal (r_1, r_2)
 - signals reflected from the DUT (a_1, a_2)
 - signals transmitted through the DUT (b_1, b_2)

By sending and receiving these signals, the VNA measures S-parameters that are ratios of the signals.

The reflection measurements (S_{11}, S_{22}) are ratios of the reflected signal to the stimulus signal.

$$S_{11} = a_1 / r_1$$

$$S_{22} = a_2 / r_2$$

The transmission measurements (S_{21}, S_{12}) are ratios of the signals that pass through the DUT.

$$S_{21} = b_2 / r_1$$

$$S_{12} = b_1 / r_2$$

This diagram illustrates the internal operation of the VNA and the flow of stimulus and receiver signals. The RF sources, receivers and logic blocks are integrated in a custom IC chip.

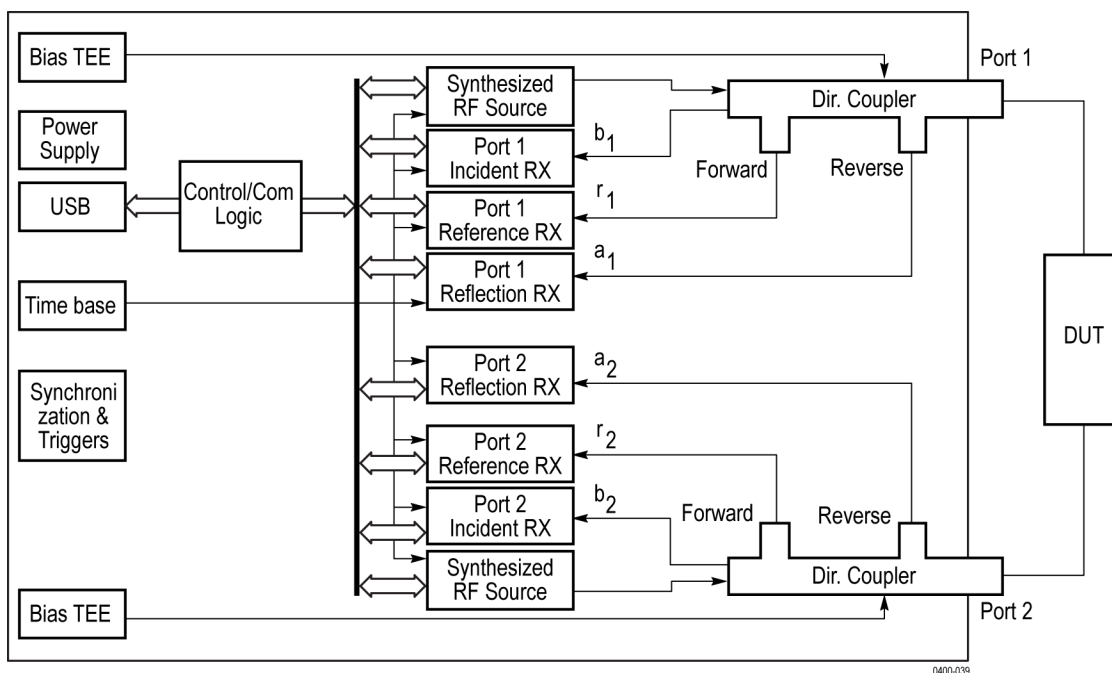

Directional coupler

Separate signals flow from the directional coupler in the forward and reverse directions. The forward direction is the direction of signal (r_1) flowing out of the VNA port. The reverse direction is the direction of signal (a_1) flowing into the VNA port.

Synthesized RF sources

There are two RF sources in the VNA. Each source is capable of synthesizing signals from 100 kHz to 3 GHz (TTR503A) and 6 GHz (TTR506A). The signals are phase-locked to a 10 MHz reference. You can generate the reference internally or provide it as an input from an external time-base. The signals from each RF source feed to the directional coupler. The signals become an output from the measurement port. This output signal is used as a stimulus for S-parameter measurements.

Receivers

There are 6 receivers in the TTR500 series VNA device. Each receiver can measure the magnitude and phase of a signal.

Incident receivers (b_1 , b_2)

Each measurement port has a receiver that measures the signal incident to the port.

Reflection receivers (a_1 , a_2)

Each measurement port has a receiver that measures the signals reflected by the DUT.

Reference receivers (r_1 , r_2)

Each measurement port has a reference receiver that measures a sample of the signal output of each port.

Controls/Communication logic

This block controls all the sources and receivers in the VNA. It also enables communication between the sources and receivers and the USB controller.

Time base

The time base provides a 10 MHz frequency and time reference. The VNA uses the time base to phase lock all receivers and sources. The time base can be used as an internal or external 10 MHz source.

USB

The USB 2.0 provides bidirectional communication between the TTR500 series VNA and the host computer. Use a cable to connect the USB port on the VNA to either a USB 2.0 or a USB 3.0 port on a computer. The TTR500A VNA uses a USB2 type B connector.

Power supply

The power supply block provides power to all the circuit elements in the VNA. The block requires a 4.75V-5.25V DC supply.

Synchronization and trigger

The VNA has options to set an external or internal trigger. The trigger is used to synchronize measurements and settings.

Bias tee

The internal bias tee feature allows you to provide a bias to the DUT through the VNA. The bias tee requires an external voltage source or power supply. Avoid powering the bias tee connectors during calibration as this can affect calibration standards.

Device information

You can find model and registration information about your VNA in **Help > About**.

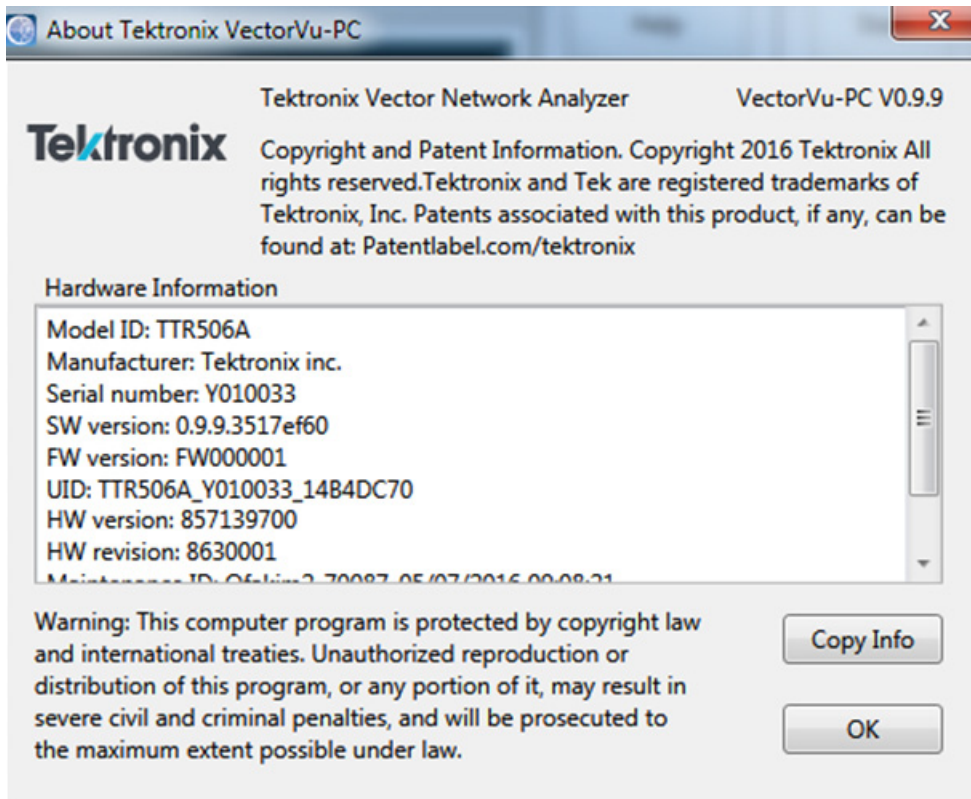

Every TTR500 unit is defined by the model followed by its serial number and a unique identifier. The identifier changes:

- When you get the unit serviced at Tektronix.
- Every time the internal USB drive is programmed.

The device information display also shows the version of VectorVu-PC that is running on your system.

Software download

Download the most current version of VectorVu-PC at www.tek.com/downloads.

Environmental specifications

Characteristic	Description	
Temperature Range		
Operating	5 °C to +50 °C	
Non-operating	−40 °C to +71 °C	
Humidity		
Operating (non-condensing)	Temperature Range	Relative Humidity
	+10 °C to +30 °C	5% to 80% RH
	+30 °C to +40 °C	5% to 75% RH
	+40 °C to +50 °C	5% to 45% RH
Altitude		
Operating	3000 meters	
Non-operating	4600 meters	

Log data

When you use the TTR500 VNA to make measurements, the instrument creates a log file. This content includes:

- Duration that the VNA was powered on
- Number of times the VNA was powered on
- Results of the power on test
- Number of switching times of the internal mechanical relay
- Number of times of overload
- Event log

To delete this log of data, in the programmatic interface, use `SCPI:SERVICE:LOGGING:CLEAR`.

Recommended calibration kits

Tektronix recommends the usage of these standard calibration kits with the TTR500 series VNA devices.

Calibration kit	Description	Matching adapter	Description
CALMECH-716	7/16 OSLT Mechanical Cal Kit 0 to 7.5 GHz (SPINNER BN 53 38 40)	THRU-716-FM	7/16 OSLT Mechanical Cal Kit MF Thru Option 0 to 7.5 GHz (SPINNER BN 756301R000)
CALMECH-N	type-N OSLT Mechanical Cal Kit 0 to 18 GHz (SPINNER BN 53 38 61)	THRU-N-FM	type-N OSLT Mechanical Cal Kit MF Thru Option 0 to 18 GHz (SPINNER BN 533918R000)
CALMECH-35MM	35mm OSLT Mechanical Cal Kit 0 to 32 GHz (Spinner BN 53 38 54)	THRU-35MM-FM	35mm OSLT Mechanical Cal Kit MF Thru Option 0 to 32 GHz (Spinner BN 533769R000)
CALSOLTNF	Calibration kit, 4-in-1 type-N (f) short, open, load, through, 9 GHz		
CALSOLTNM	Calibration kit, 4-in-1 type-N(m) short, open, load, through, 9 GHz		
CALSOLT35F	Calibration kit, 4-in-1 3.5 mm (f) short, open, load, through, 13 GHz		
CALSOLT35M	Calibration kit, 4-in-1 3.5 mm (m) short, open, load, through, 13 GHz		
CALSOLT716F	Calibration kit, 4-in-1 7/16 (f) short, open, load, through, 6 GHz		
CALSOLT716M	Calibration kit, 4-in-1 7/16 (m) short, open, load, through, 6 GHz		
CALSOLTNF-75	Calibration kit, 4-in-1 type-N(f) short, open, load, through, 75 Ω , 3 GHz		
CALSOLTNM-75	Calibration kit, 4-in-1 type-N(m) short, open, load, through, 75 Ω , 3 GHz		

Measurement accessories

These accessories are available for use with the TTR500 series VNA instruments. Contact your local Tektronix office or order online at www.tek.com. Specify the part number for the accessory you need.

Product	Tektronix part number	Description
Rack mount kit	TTR500RACK	Rack mount kit for TTR500 series VNA. Holds up to two TTR500 series instruments.
Transit case	TTR500TRANSIT	Transit case for TTR500 series VNA.
Demo kit	TTR500-DEMO-KIT	Demo kit for TTR500 VNAs (case, calibration kit, filter, two cables).

Attenuators and bias tee

Tektronix part number	Description
011022200	Attenuator, fixed, 10 dB, 2 W, DC-18 GHz, type-N(F) to type-N(F)
011022300	Attenuator, fixed; 10 dB, 2 W, DC-18 GHz, type-N(M) to type-N(F)
011022400	Attenuator, fixed; 10 dB, 2 W, DC-18 GHz, type-N(M) to type-N(M)
011022500	Attenuator, fixed; 40 dB, 100 W, DC-6 GHz, type-N(M) to type-N(F)
011022600	Attenuator, fixed; 40 dB, 50 W, DC-18 GHz, 1.3 VSWR TYP; type-N(M) to type-N(F)
011022700	Bias tee, type N(M) RF, type N(F) RF+DC, BNC(F) BIAS, 1 W, 0.5 A, 2.5 MHz-6 GHz
011022800	Attenuator, fixed; 3 DB, 2 W, DC-18 GHZ, type-N(M) to type-N(F)

Cables

Tektronix part number	Description
012174500	Cable, rugged, phase-stable, type-N(M) to type-N(F), 5ft or 1.5m
012174600	Cable, rugged, phase-stable, type-N(M) to type-N(F), 3.28ft or 1m
012174700	Cable, rugged, phase-stable, type-N(M) to 7/16(F), 60 cm
012174800	Cable, rugged, phase-stable, type-N(M) to 7/16(F), 3.28ft or 1m
012174900	Cable, rugged, phase-stable, type-N(M) to 7/16(F), 5ft or 1.5m
012175000	Cable, rugged, phase-stable, type-N(M) to 7/16(M), 3.28ft or 1m
012175100	Cable, rugged, phase-stable, type-N(M) to 7/16(M), 5ft or 1.5m
012175200	Cable, rugged, phase-stable, type-N(M) to 7/16(M), 60 cm
012175300	Cable, rugged, phase-stable, type-N(M) to DIN 9.5(F), 60 cm
012175400	Cable, rugged, phase-stable, type-N(M) to DIN 9.5(F), 3.28ft or 1m
012175500	Cable, rugged, phase-stable, type-N(M) to DIN 9.5(F), 5ft or 1.5m
012175600	Cable, rugged, phase-stable, type-N(M) to DIN 9.5(M), 3.28ft or 1m

Tektronix part number	Description
012175700	Cable, rugged, phase-stable, type-N(M) to DIN 9.5(M), 5ft or 1.5m
012175800	Cable, rugged, phase-stable, type-N(M) to DIN 9.5(M), 60 cm
012175900	Cable, rugged, phase-stable, type-N(M) to TNC(F), 3.28ft or 1m
012176000	Cable, rugged, phase-stable, type-N(M) to TNC(F), 5ft or 1.5m
012176100	Cable, rugged, phase-stable, type-N(M) to TNC(F), 60 cm
012176200	Cable, rugged, phase-stable, type-N(M) to TNC(M), 60 cm
012176300	Cable, rugged, phase-stable, type-N(M) to TNC(M), 3.28ft or 1m
012176400	Cable, rugged, phase-stable, type-N(M) to TNC(M), 5ft or 1.5m
012176500	Cable, rugged, phase-stable, type-N(M) to type-N(F), 60cm
012176600	Cable, rugged, phase-stable, type-N(M) to type-N(F), 3.28ft or 1m
012176700	Cable, rugged, phase-stable, type-N(M) to type-N(M), 3.28ft or 1m
012176800	Cable, rugged, phase-stable, type-N(M) to type-N(M), 60 cm
012176900	Cable, rugged, phase-stable, type-N(M) to type-SMA(F), 60 cm
012177000	Cable, rugged, phase-stable, type-N(M) to type-SMA(F), 3.28ft or 1m
012177100	Cable, rugged, phase-stable, type-N(M) to type-SMA(F), 5ft or 1.5m
012177200	Cable, rugged, phase-stable, type-N(M) to type-SMA(M), 60 cm
012177300	Cable, rugged, phase-stable, type-N(M) to type-SMA(M), 3.28ft or 1m
012177400	Cable, rugged, phase-stable, type-N(M) to type-SMA(M), 5ft or 1.5m

Adapters and test cables

Tektronix part number	Description
013040200	Adapter, coaxial, 50 Ω type-N (M) to type 7/16(M), 7.5 GHz
013040300	Connector, adapter, coaxial, 50 Ω type-N(M) to type DIN 4.1/9.5(M), 11 GHz, VSWR 1.2
013040400	Adapter, coaxial, 50 Ω type-N(M) to type-7/16 (F) 6GHz
013040500	Connector, adapter, coaxial, 50 Ω type-N(M) to type-DIN 4.1/9.5(F), 11 GHz, VSWR 1.2
013040600	Adapter, coaxial, 50 Ω type-N(M) to type-SMA(F), 18 GHz
013040700	Adapter, coaxial, 50 Ω type-N(M) to type-SMA(M), 18 GHz
013040800	Adapter, coaxial, 50 Ω type-N(M) to type-TNC(F), 18 GHz
013040900	Adapter, coaxial, 50 Ω type-N(M) to type-TNC(M), 18 GHz
013041100	Coaxial adapter, 50 Ω type-N (M) to type-N (F) 18 GHz
013041300	Coaxial adapter, MIN loss impedance matching PAD, type-N(M) 50 Ω to type-BNC(M) 75 Ω , 3 GHz, 1.35 MAX VSWR, 5.7+/-0.5dB INS loss
013041500	PAD, 50/75 Ω , minimum loss, type-N(M) 50 Ω to type-F(M) 75 Ω
013042200	Coaxial adapter, MIN loss impedance matching PAD, 50 Ω N(M) to 75 Ω BNC(F), 1.35 VSWR MAX, 5.7+/-0.5dB INS loss, 3 GHz
015078700	PAD, 50/75 Ω , minimum loss, type-N(M) 50 Ω to type-F(F) 75 Ω

Tektronix part number	Description
015078800	PAD, 50/75 Ω , minimum loss, type-N(M) 50 Ω to type-N(F) 75 Ω
020316600	MFG ASSY; tracking generator and GPS demo kit
119873300	Antenna; active,GPS & glonass, magnetic mount, 5M Cable, 3V, 8MA TYP, SMA Conn, RG-174 Cable

Accessory cables

Tektronix part number	Description
012173800	Cable ASSY; coaxial, RFD, 50 Ω , 40 inch, N-type, both ends, male
012048200	Cable Assembly, RF; coaxial; RFD, 50 Ω , (175-1455-00), 36 inch L, BNC male to BNC male, strain relief boots
013041000	Adapter, coaxial, 50 Ω type-N(F) to type-N(F) 18 GHz
013041200	Adapter, coaxial, 50 Ω , type-N(M) to type-N(M), 18 GHz

Calibration kits

Tektronix part number	Description
CALMECH-716	7/16 OSLT mechanical calibration kit 0 to 7.5 GHz (SPINNER BN 53 38 40)
CALMECH-N	Type-N OSLT mechanical calibration kit 0 to 18 GHz (SPINNER BN 53 38 61)
CALMECH-35MM	35mm OSLT mechanical calibration kit 0 to 32 GHz (Spinner BN 53 38 54)
THRU-716-FM	7/16 OSLT mechanical calibration kit MF Thru Option 0 to 7.5 GHz (SPINNER BN 756301R000)
THRU-N-FM	type-N OSLT mechanical calibration kit MF Thru Option 0 to 18 GHz (SPINNER BN 533918R000)
THRU-35MM-FM	35mm OSLT mechanical calibration kit MF Thru Option 0 to 32 GHz (Spinner BN 533769R000)
CALSOLTNF	Calibration kit, 4-in-1 type-N (f) short, open, load, through, 9 GHz
CALSOLTNM	Calibration kit, 4-in-1 type-N (m) short, open, load, through, 9 GHz
CALSOLT35F	Calibration kit, 4-in-1 3.5 mm (f) short, open, load, through, 13 GHz
CALSOLT35M	Calibration kit, 4-in-1 3.5 mm (m) short, open, load, through, 13 GHz
CALSOLT716F	Calibration kit, 4-in-1 7/16 (f) short, open, load, through, 6 GHz
CALSOLT716M	Calibration kit, 4-in-1 7/16 (m) short, open, load, through, 6 GHz
CALSOLTNF-75	Calibration kit, 4-in-1 type-N (f) short, open, load, through, 75 Ω , 3 GHz
CALSOLTNM-75	Calibration kit, 4-in-1 type-N (m) short, open, load, through, 75 Ω , 3 GHz

Standard Functions

Use standard Windows applications to perform these operations:

- Screen capture of images
- Print screen – trace or channel display

Maintain your VNA

To obtain the best performance from your VNA, follow these recommendations when using the TTR500 instrument:

- Calibrate the instrument annually.
- Format the internal USB flash memory at least once every year. Refer to instructions in the security and declassification manual.
- In the event of any damage to the instrument, contact the service department at Tektronix so that an authorized service professional can repair the instrument.

Clean the VNA

- When necessary, clean the exterior surface of the instrument with a dry, lint-free cloth or a soft-bristle brush. If any dirt remains, use a cloth or swab dipped in a 75% isopropyl alcohol solution.
- Use a swab to clean narrow spaces around controls and connectors.
- Do not use abrasive compounds on any part of the instrument.
- Do not use chemical cleaning agents as they can damage the chassis.
- Avoid chemicals that contain benzene, toluene, xylene, acetone, or similar solvents.



CAUTION. *Avoid getting moisture inside the instrument when cleaning the exterior; use just enough moisture to dampen the cloth or swab. Use only deionized or distilled water when cleaning. Use a 75% isopropyl alcohol as a cleanser and rinse with deionized or distilled water.*

Return the VNA

In case you need to return the VNA to Tektronix:

- Back up any calibration data stored on the VNA.
- When repacking the instrument for shipping, use the original packaging. If the packaging is unavailable or unfit for use, contact your local Tektronix representative to obtain new packaging.
- Seal the shipping carton with an industrial stapler or strapping tape.

Troubleshoot the VNA

If the VNA displays unexpected or erratic behavior, try these corrections:

Behavior	Recommended action
The VNA does not start.	Check to see if the VNA is connected to a DC power source. If the LED light does not function, contact the service department.
The LED light does not turn green.	Disconnect the instrument for a few minutes. Reconnect and open VectorVu-PC.
The measurement value is abnormal.	<ul style="list-style-type: none"> ■ Check the connection cables, DUT, and all other connections. ■ Repeat the calibration procedure to obtain the correct error correction factor. ■ Check the selection and definition of the calibration kit.
VectorVu-PC stalls or crashes during an operation.	Disconnect the VNA. Reconnect after a couple of minutes and open VectorVu-PC.
An error or warning appears in the instrument status bar.	Look up the message and its description in IEEE error messages and VNA error messages .

IEEE error messages

This is a list of IEEE standard error messages that display in the Instrument Status bar to indicate an improper setting or incorrect action.

Error ID	Message	Description
100	Command syntax error.	SCPI command error.
101	Invalid character.	Command contains an invalid character.
103	Invalid separator.	Delimiter expected, different character sent.
104	Data type error.	A wrong data element type was received.
105	Parameter not allowed.	Number of parameters exceeds command syntax.
106	Missing parameter.	Number of parameters is less than command syntax.
107	Command not supported.	The command has a valid SCPI syntax but not supported by the instrument.
108	Header suffix out of range.	The unit of the header is out of range.
110	Numeric data error.	Numeric parameter has invalid syntax.
111	Invalid character in number.	A character is invalid in a numeric parameter - e.g. letter found in a decimal value.
112	Exponent too large.	Absolute value of the exponent exceeds 32,000.
113	Too many digits.	More than 255 digits in a number.
114	Numeric data not allowed.	A numeric data element was received at an invalid position.

120	Invalid suffix.	Suffix has invalid syntax or value.
121	Suffix too long.	Unit has more than 11 characters.
122	Suffix not allowed.	A suffix is attached to a numeric value which does not have units.
130	Invalid character data.	An invalid character was found in a character data element.
131	Character data not allowed.	A character data element was received at an invalid position.
140	String data error.	The content of the string has syntax error.
141	Invalid string data.	The character string is invalid.
142	String data not allowed.	A character string data element was received at an invalid position.
143	String too long.	String longer than 255 characters.
150	Invalid block data.	The block data is invalid, possibly due to block data length mismatch.
160	Expression error.	Expression syntax error.
161	Invalid expression.	The expression data element is invalid.
162	Expression data not allowed.	An expression data element was received at an invalid position.
200	Execution error.	Error in execution.
201	Measurement in progress - init ignored.	Init command received while measurement is in progress. Init command is ignored.
210	Parameter error.	General parameter error.
211	Unexpected trigger - ignored.	A trigger is detected when not in "waiting for trigger" state.
212	Data out of range.	Data element out of range was received.
214	Illegal parameter value.	Measurement parameter is invalid - e.g. the source or receive port are invalid.
220	File not found.	Specified file not found.
221	File name error.	File name syntax error.
301	Error queue overflow.	An error occurred when there is only one slot available in the error queue.
401	Query interrupted.	Data bytes are received before a response of a previous query.
402	Query unterminated.	Instrument is designated as the talker and an incomplete program message is received.
403	Query deadlocked.	Both input and output buffers are full.
404	Query unterminated after indefinite response.	Query asking for indefinite response is followed by a new query.
500	Data array contains NAN values.	Data array sent to user contains NAN values.

VNA error messages

This is a list of instrument-specific error messages that display in the Instrument Status bar to indicate an improper setting or incorrect action.

Error ID	Message	Description
10	Unable to calculate calibration data. Missing standards.	Some standards were not measured for the selected calibration method.
11	Duplicate port numbers.	Identical port numbers specified in a list of ports.
12	No calibration method selected.	Unable to save calibration data before selecting a calibration method.
13	Specified error term is invalid for the selected calibration method.	This error term is not applicable for the selected calibration method.
14	Normal calibration not allowed in frequency offset mode.	Unable to execute normal calibration in frequency offset mode.
15	Scalar mixer calibration not allowed when frequency offset mode is disabled.	Scalar mixer calibration not allowed when frequency offset mode is disabled.
16	Unable to perform partial override. No calibration method specified.	Unable to perform partial override when the calibration method is not specified.
17	Correction not enabled. No calibration data exists.	Error correction cannot be enabled because no calibration data exists.
20	eCal module does not support specified number of ports.	Unable to run multi-port calibration. eCal module has insufficient number of ports.
21	eCal failure.	Unable to configure or read from eCal module.
22	eCal not connected in RF path	eCal auto-detect does not recognize RF connectivity between the VNA and the eCal module
23	Unable to perform confidence check for mixed mode S-parameters.	Unable to perform confidence check for mixed mode S-parameters.
24	Characterization not found in eCal module.	Characterization entry does not exist in eCal module memory.
30	Target value not found.	Target value not found within the specified excursion in target search.
31	Peak not found.	Peak not found within the specified excursion in peak search.
40	Selected channel not on display.	Selected active channel is not on display.
41	Selected trace does not exist.	Selected active trace does not exist.
42	No valid memory trace.	Unable to perform memory operation where there is no valid memory trace.
43	Time domain processing not supported in frequency offset mode.	Unable to perform time domain transform or gating in frequency offset mode.

Error ID	Message	Description
44	Fixture simulator not allowed in frequency offset mode.	Unable to run fixture simulator in frequency offset mode.
45	Auto port extension not allowed in power sweep or frequency offset mode.	Auto port extension not allowed in power sweep or frequency offset mode.
46	No valid measurement to save in file.	Unable to save trace data. No valid trace available.
50	Frequency out of range.	Selected frequency outside instrument range.
60	Power meter not found.	Unable to locate power meter based on specified VISA resource name.
61	Power meter not stable.	Power meter reading exceeds tolerance or fails to stabilize within predefined time.
62	Signal generator not found.	Unable to locate signal generator based on specified VISA resource name.
63	Unable to control external signal generator.	Unable to control external signal generator.
64	Unable to communicate with power meter.	Unable to communicate with power meter.
65	Power meter already claimed.	Power meter already claimed by another application.
66	Selected power sensor does not support the configured sweep range.	Selected power sensor does not support the configured sweep range. Unable to perform power calibration.
100	Load failed.	Load from file failed.
101	Save failed.	Save to file failed.
102	THRU standard should be defined with S2P file.	THRU standard should be defined with S2P file.
103	Standard should be defined with S1P file.	Standard should be defined with S1P file.
104	Factory calibration not found.	Unable to locate factory calibration zip file for this instrument. Default calibration used instead.
200	Option not installed.	Unable to perform optional function. This option is not installed in the instrument.
210	PLL not locked.	Measurement data is not valid. At least one frequency point resulted in an unlocked PLL.
220	Power trip event. RF turned off.	Power received was too high. Source turned off to prevent damage to VNA.
230	Self test failure.	Instrument self test failed.
300	Unable to estimate adapter length in zero span.	Unable to estimate adapter length in zero span.
400	Invalid equation expression	Invalid equation is specified in the equation editor
401	Invalid equation label	Invalid equation label.
500	Instrument disconnected	The instrument has been disconnected.
501	Instrument is not connected.	Unable to connect to instrument that is not connected to host.
502	Instrument connection failed.	Instrument connection failed.

Error ID	Message	Description
503A	Instrument connection failed.	Instrument already claimed.
504	Instrument connection failed.	Instrument not activated.
505	Instrument connection failed.	Device is not connected to USB.
506A	USB Storage set state failure.	Unable to set state of USB Storage.
507	USB Storage get state failure.	Unable to get state of USB Storage.
508	Instrument activation failed.	Instrument already claimed.
509	Instrument activation failed.	Instrument already activated.
510	Instrument activation failed.	Device is not connected to USB.
511	Instrument temperature has exceeded safe operating range.	The temperature of the TTR500 unit has exceeded safe operating range. VectorVu-PC has switched to offline mode.
601	Unable to load power meter DLL.	Unable to load power meter DLL. Verify DLL is installed and in execution path.
602	Incompatible power meter DLL.	Power meter installation is not compatible with this application.
603	Power meter initialization failed.	Power meter initialization failed.
604	Power meter measurement failed.	Power meter measurement failed.
700	Insufficient memory for current sweep settings. Unable to start sweep recording.	Insufficient memory for current sweep settings. Unable to start sweep recording.
1000	Calibration interpolated.	Measurement and calibration stimulus points are not identical. Calibration data was interpolated.
1001	Measurement conditions not identical to calibration conditions.	Measurement and calibration conditions are not identical. Error correction can be inaccurate.
1002	Change in global power or IFBW. Segment table updated accordingly.	Global power or IFBW has changed. The per-segment power / IFBW were overridden in the segment table.

Warnings and notifications

This is a list of warning messages and notifications that display in the Instrument Status bar.

Warnings

Warning ID	Message	Description
1000	Calibration interpolated	Measurement and calibration stimulus points are not identical. Calibration data was interpolated
1001	Measurement conditions not identical to calibration	Measurement and calibration conditions (e.g. power, IF BW) are not identical. Error correction might not be accurate
1002	Changed global power or IF BW - updated segment table accordingly	Global power or IF BW changed - the per-segment power / IF BW were overridden in the segment table

Notifications

Notification ID	Message	Description
2000	Instrument connected	A TTR500 unit has been connected.