

# Model 2750 Multimeter/Switch System

## User's Manual

2750-900-01 Rev. G June 2023



2750-900-01G

Model 2750  
Multimeter/Switch System  
User's Manual

© 2023, Keithley Instruments, LLC

Cleveland, Ohio, U.S.A.

All rights reserved.

Any unauthorized reproduction, photocopy, or use of the information herein, in whole or in part, without the prior written approval of Keithley Instruments, LLC, is strictly prohibited.

These are the original instructions in English.

All Keithley Instruments product names are trademarks or registered trademarks of Keithley Instruments, LLC. Other brand names are trademarks or registered trademarks of their respective holders.

Microsoft, Visual C++, Excel, and Windows are either registered trademarks or trademarks of Microsoft Corporation in the United States and/or other countries.

Document number: 2750-900-01 Rev. G June 2023

The following safety precautions should be observed before using this product and any associated instrumentation. Although some instruments and accessories would normally be used with nonhazardous voltages, there are situations where hazardous conditions may be present.

This product is intended for use by personnel who recognize shock hazards and are familiar with the safety precautions required to avoid possible injury. Read and follow all installation, operation, and maintenance information carefully before using the product. Refer to the user documentation for complete product specifications.

If the product is used in a manner not specified, the protection provided by the product warranty may be impaired.

The types of product users are:

**Responsible body** is the individual or group responsible for the use and maintenance of equipment, for ensuring that the equipment is operated within its specifications and operating limits, and for ensuring that operators are adequately trained.

**Operators** use the product for its intended function. They must be trained in electrical safety procedures and proper use of the instrument. They must be protected from electric shock and contact with hazardous live circuits.

**Maintenance personnel** perform routine procedures on the product to keep it operating properly, for example, setting the line voltage or replacing consumable materials. Maintenance procedures are described in the user documentation. The procedures explicitly state if the operator may perform them. Otherwise, they should be performed only by service personnel.

**Service personnel** are trained to work on live circuits, perform safe installations, and repair products. Only properly trained service personnel may perform installation and service procedures.

Keithley products are designed for use with electrical signals that are measurement, control, and data I/O connections, with low transient overvoltages, and must not be directly connected to mains voltage or to voltage sources with high transient overvoltages. Measurement Category II (as referenced in IEC 60664) connections require protection for high transient overvoltages often associated with local AC mains connections. Certain Keithley measuring instruments may be connected to mains. These instruments will be marked as category II or higher.

Unless explicitly allowed in the specifications, operating manual, and instrument labels, do not connect any instrument to mains.

Exercise extreme caution when a shock hazard is present. Lethal voltage may be present on cable connector jacks or test fixtures. The American National Standards Institute (ANSI) states that a shock hazard exists when voltage levels greater than 30 V RMS, 42.4 V peak, or 60 VDC are present. A good safety practice is to expect that hazardous voltage is present in any unknown circuit before measuring.

Operators of this product must be protected from electric shock at all times. The responsible body must ensure that operators are prevented access and/or insulated from every connection point. In some cases, connections must be exposed to potential human contact. Product operators in these circumstances must be trained to protect themselves from the risk of electric shock. If the circuit is capable of operating at or above 1000 V, no conductive part of the circuit may be exposed.

Do not connect switching cards directly to unlimited power circuits. They are intended to be used with impedance-limited sources. NEVER connect switching cards directly to AC mains. When connecting sources to switching cards, install protective devices to limit fault current and voltage to the card.

Before operating an instrument, ensure that the line cord is connected to a properly-grounded power receptacle. Inspect the connecting cables, test leads, and jumpers for possible wear, cracks, or breaks before each use.

When installing equipment where access to the main power cord is restricted, such as rack mounting, a separate main input power disconnect device must be provided in close proximity to the equipment and within easy reach of the operator.

For maximum safety, do not touch the product, test cables, or any other instruments while power is applied to the circuit under test. ALWAYS remove power from the entire test system and discharge any capacitors before connecting or disconnecting cables or jumpers, installing or removing switching cards, or making internal changes, such as installing or removing jumpers.

Do not touch any object that could provide a current path to the common side of the circuit under test or power line (earth) ground. Always make measurements with dry hands while standing on a dry, insulated surface capable of withstanding the voltage being measured.

For safety, instruments and accessories must be used in accordance with the operating instructions. If the instruments or accessories are used in a manner not specified in the operating instructions, the protection provided by the equipment may be impaired.

Do not exceed the maximum signal levels of the instruments and accessories. Maximum signal levels are defined in the specifications and operating information and shown on the instrument panels, test fixture panels, and switching cards.

When fuses are used in a product, replace with the same type and rating for continued protection against fire hazard.

Chassis connections must only be used as shield connections for measuring circuits, NOT as protective earth (safety ground) connections.

If you are using a test fixture, keep the lid closed while power is applied to the device under test. Safe operation requires the use of a lid interlock.

If a  screw is present, connect it to protective earth (safety ground) using the wire recommended in the user documentation.

The  symbol on an instrument means caution, risk of hazard. The user must refer to the operating instructions located in the user documentation in all cases where the symbol is marked on the instrument.

The  symbol on an instrument means warning, risk of electric shock. Use standard safety precautions to avoid personal contact with these voltages.

The  symbol on an instrument shows that the surface may be hot. Avoid personal contact to prevent burns.

The  symbol indicates a connection terminal to the equipment frame.

If this  symbol is on a product, it indicates that mercury is present in the display lamp. Please note that the lamp must be properly disposed of according to federal, state, and local laws.

The **WARNING** heading in the user documentation explains hazards that might result in personal injury or death. Always read the associated information very carefully before performing the indicated procedure.

The **CAUTION** heading in the user documentation explains hazards that could damage the instrument. Such damage may invalidate the warranty.

The **CAUTION** heading with the  symbol in the user documentation explains hazards that could result in moderate or minor injury or damage the instrument. Always read the associated information very carefully before performing the indicated procedure. Damage to the instrument may invalidate the warranty.

Instrumentation and accessories shall not be connected to humans.

Before performing any maintenance, disconnect the line cord and all test cables.

To maintain protection from electric shock and fire, replacement components in mains circuits — including the power transformer, test leads, and input jacks — must be purchased from Keithley. Standard fuses with applicable national safety approvals may be used if the rating and type are the same. The detachable mains power cord provided with the instrument may only be replaced with a similarly rated power cord. Other components that are not safety-related may be purchased from other suppliers as long as they are equivalent to the original component (note that selected parts should be purchased only through Keithley to maintain accuracy and functionality of the product). If you are unsure about the applicability of a replacement component, call a Keithley office for information.

Unless otherwise noted in product-specific literature, Keithley instruments are designed to operate indoors only, in the following environment: Altitude at or below 2,000 m (6,562 ft); temperature 0 °C to 50 °C (32 °F to 122 °F); and pollution degree 1 or 2.

To clean an instrument, use a cloth dampened with deionized water or mild, water-based cleaner. Clean the exterior of the instrument only. Do not apply cleaner directly to the instrument or allow liquids to enter or spill on the instrument. Products that consist of a circuit board with no case or chassis (e.g., a data acquisition board for installation into a computer) should never require cleaning if handled according to instructions. If the board becomes contaminated and operation is affected, the board should be returned to the factory for proper cleaning/servicing.

Safety precaution revision as of June 2018.

# Table of contents

---

- Introduction..... 1-1**
  - Welcome ..... 1-1
  - Extended warranty ..... 1-1
  - Contact information ..... 1-1
  - Customer documentation ..... 1-2
  - Product software and drivers ..... 1-2
  - What you should have received ..... 1-3
  - About this manual ..... 1-3
  - General ratings ..... 1-4
  
- Installation..... 2-1**
  - Introduction ..... 2-1
  - Switching module installation and connections ..... 2-1
    - Module installation ..... 2-2
    - Connections ..... 2-2
  - Turning the instrument on and off ..... 2-3
  - Power-up sequence ..... 2-4
  - Warmup period..... 2-5
  - Identifying installed switching modules ..... 2-5
  - Keyclick ..... 2-5
  - Display..... 2-6
  - Status and error messages ..... 2-6
  - Defaults and user setups ..... 2-6
    - Saving a user setup ..... 2-7
    - Saving a power-on setup ..... 2-7
    - Restoring a setup ..... 2-8
    - Default settings ..... 2-8
  
- Instrument description ..... 3-1**
  - Front panel ..... 3-1
    - 1 Special keys and power switch ..... 3-1
    - 2 Function and operation keys ..... 3-2
    - 3 Range keys ..... 3-3
    - 4 Display annunciators ..... 3-4
    - 5 Slot indicators..... 3-5
    - 6 INPUTS switch ..... 3-5
    - 7 Front-panel inputs ..... 3-5
  - Rear panel..... 3-5

<b>Operation</b> .....	<b>4-1</b>
Introduction .....	4-1
Basic DMM measurements using front-panel inputs .....	4-2
Closing and opening channels using system channel operation .....	4-3
Simple scanning.....	4-5
Basic DMM operation.....	4-7
DMM measurement capabilities .....	4-8
High energy circuit safety precautions .....	4-9
Voltage measurements (DCV and ACV) .....	4-10
Current measurements (DCI and ACI) .....	4-14
Resistance measurements ( $\Omega 2$ and $\Omega 4$ ) .....	4-16
Temperature measurements .....	4-25
Frequency and period measurements.....	4-36
Continuity testing.....	4-39
Range.....	4-40
Measurement ranges and maximum readings .....	4-41
Relative offset .....	4-41
Rate.....	4-42
<b>Switch module channel operation</b> .....	<b>5-1</b>
Closing and opening switching module channels .....	5-1
Close/open overview.....	5-1
Channel assignments.....	5-3
System channel operation .....	5-3
2-wire functions .....	5-4
4-wire functions (paired channels) .....	5-5
Controlling the system channel .....	5-6
Non-amp and non-measure switching modules .....	5-9
Identifying installed modules.....	5-9
CARD menu.....	5-10
<b>Maintenance</b> .....	<b>6-1</b>
Introduction .....	6-1
Finding the serial number of the instrument.....	6-1
AMPS fuse replacement (front-panel AMPS input) .....	6-2
Setting line voltage and replacing fuse .....	6-3
<b>Status and error messages</b> .....	<b>7-1</b>
Status and error messages .....	7-1
<b>Next steps</b> .....	<b>8-1</b>
Additional 2750 information .....	8-1

---

## Introduction

### In this section:

Welcome .....	1-1
Extended warranty .....	1-1
Contact information .....	1-1
Customer documentation .....	1-2
Product software and drivers.....	1-2
What you should have received .....	1-3
About this manual .....	1-3
General ratings.....	1-4

## Welcome

Thank you for choosing a Keithley Instruments product. The Model 2750 combines precision measurement, switching, and control in a tightly integrated enclosure for benchtop applications. The Model 2750 offers extended low ohms measurement capability and supports up to five 7700 switch cards for a maximum of 200, 2-pole multiplexed channels. It also contains a built-in 20 mV clamp that helps protect sensitive devices from damage and prevents self-heating errors during dry circuit testing.

This manual describes basic operation of the Model 2750.

## Extended warranty

Additional years of warranty coverage are available on many products. These valuable contracts protect you from unbudgeted service expenses and provide additional years of protection at a fraction of the price of a repair. Extended warranties are available on new and existing products. Contact your local Keithley Instruments office, sales partner, or distributor for details.

## Contact information

If you have any questions after you review the information in this documentation, please contact your local Keithley Instruments office, sales partner, or distributor. You can also call the Tektronix corporate headquarters (toll-free inside the U.S. and Canada only) at 1-800-833-9200. For worldwide contact numbers, visit [tek.com/contact-tek](http://tek.com/contact-tek).



## Customer documentation

The documentation for the 2750 includes a User's Manual and Reference Manual. You can access them from [tek.com/keithley](https://www.tek.com/keithley).

- **User's Manual:** Includes installation, instrument description, operation, and maintenance information.
- **Reference Manual:** Includes advanced operation topics and maintenance information. Programmers looking for a command reference and users looking for an in-depth description of how the instrument works should refer to the Reference Manual.

## Product software and drivers

Go to the [Product Support and Downloads web page](#) to download drivers and software for your instrument.

Available drivers and software include:

- **KickStart Software:** Enables quick test setup and data visualization when using one or more instruments.
- **IVI-COM Driver:** An IVI instrument driver you can use to create your own test applications in C/C++, VB.NET, or C# programming languages. It can also be called from other languages that support calling a DLL or ActiveX (COM) object. Refer to [IVI Foundation \(ivifoundation.org\)](https://www.ivifoundation.org) for additional information.
- **LabVIEW™ Software drivers:** Drivers to communicate with NI™ LabVIEW™ Software.
- **Keithley I/O layer:** Manages the communications between Keithley instrument drivers and software applications and the instrument itself. The I/O Layer handles differences in communications required to support GPIB, serial, ethernet, and other communications buses so that drivers and software applications do not need to handle the differences themselves.

## What you should have received

Model 2750 was carefully inspected electrically and mechanically before shipment. After unpacking all items from the shipping carton, check for any obvious signs of physical damage that may have occurred during transit. There may be a protective film over the display lens, which you can remove. Report any damage to the shipping agent immediately.

Save the original packing carton for possible future shipment.

The following items are included with every Model 2750 order:

- Model 2750 with line cord
- Safety test leads
- Accessories as ordered
- Certificate of calibration

## About this manual

This manual provides installation and basic operating information for the 2750. It includes:

**Installation:** Installation and power up information.

**Instrument description:** Descriptions of the options on the instrument front and rear panels.

**Operation:** Basic operating information and quick start exercises.

**Switch module channel operation:** Basic information on using the front panel to control switching.

**Maintenance:** Information on finding the serial number of the instrument, replacing the fuses, and setting the line voltage.

**Status and error messages:** The status and event numbers and messages.

**Next steps:** Provides information on additional resources for using your Model 2750 instrument.

## General ratings

Category	Specification
Power supply	100 V / 120 V / 220 V / 240 V
Line frequency	50 Hz to 60 Hz and 400 Hz, automatically sensed at power-up
Input and output connections	See <a href="#">Front panel</a> (on page 3-1) and <a href="#">Rear panel</a> (on page 3-5)
Environmental conditions	<b>For indoor use only.</b> <b>Altitude:</b> Maximum 2,000 meters (6,562 feet) above sea level <b>Operating:</b> 0 °C to 50 °C, 80% relative humidity up to 35 °C. <b>Storage:</b> -40 °C to 70 °C

---

# Installation

## In this section:

Introduction.....	2-1
Switching module installation and connections .....	2-1
Turning the instrument on and off.....	2-3
Power-up sequence.....	2-4
Warmup period.....	2-5
Identifying installed switching modules.....	2-5
Keyclick .....	2-5
Display.....	2-6
Status and error messages .....	2-6
Defaults and user setups.....	2-6

## Introduction

This section provides the information you need to install switching modules, power on the instrument, and save or restore setups.

## Switching module installation and connections

To use switching functions, a switching module must be installed in the mainframe. A switching module can be installed by the user, however external connections to the switching module are only to be performed by qualified service personnel.

---

### **WARNING**

The following information is intended for qualified service personnel. Do not make module connections unless qualified to do so.

To prevent electric shock that could result in serious injury or death, adhere to the following safety precautions:

- Before removing or installing a switch module in the mainframe, make sure the mainframe is turned off and disconnected from line power.
- Before making or breaking connections, make sure the power is removed from all external circuitry.

Do not connect signals that may exceed the maximum specifications of the model or external wiring. Complete specifications for the 2750 are available on [tek.com/keithley](http://tek.com/keithley).

---

## Module installation

---

### **WARNING**

Slot covers must be installed on unused slots to prevent personal contact with high-voltage circuits. Failure to recognize and observe standard safety precautions could result in personal injury or death due to electric shock.

---

#### *To install a switching module into the Model 2750:*

1. Turn the Model 2750 off.
2. Disconnect the power line cord and any other cable connected to the rear panel.
3. Position the Model 2750 so you are facing the rear panel.
4. Remove the slot cover plate from the mainframe slot. Retain the plate and screws for future use.
5. With the top cover of the switching module facing up, slide the module into an empty slot. For the last ¼ inch, press in firmly to mate the module connector to the mainframe connector.
6. On each side of the module, there is a mounting screw. Tighten these two screws to secure the module to the mainframe. Do not overtighten.
7. Reconnect the power line cable and any other cables to the rear panel.
8. Turn on the Model 2750. The model number of the switching module is briefly displayed.

## Connections

---

### **WARNING**

If the front-panel terminals and the switching module terminals are connected at the same time, the test lead insulation must be rated to the highest voltage that is connected. For example, if 1000 V is connected to the front-panel input, the test lead insulation for the switching module must also be rated for 1000 V.

Dangerous arcs of an explosive nature in a high energy circuit can cause severe personal injury or death. If the multimeter is connected to a high energy circuit when set to a current range, low resistance range, or any other low impedance range, the circuit is virtually shorted. Dangerous arcing can result even when the multimeter is set to a voltage range if the minimum voltage spacing is reduced in the external connections. For details on how to safely make high energy measurements, see [High energy circuit safety precautions](#) (on page 4-9).

As described in the International Electrotechnical Commission (IEC) Standard IEC 664, the Model 2750 is Installation Category I and must not be connected to mains.

---

For the switching modules, detailed connection and wiring information is provided in the documentation for the switching module, available at [tek.com/keithley](http://tek.com/keithley).

## Turning the instrument on and off

The 2750 operates from a line voltage of 100 V to 240 V at a frequency of 50 Hz or 60 Hz. Make sure the operating voltage in your area is compatible. The 2750 operates at line frequencies from 45 Hz to 66 Hz, and 360 Hz to 440 Hz. There are no user settings for line frequency. It is automatically sensed at power-up.

Follow the procedure below to connect the 2750 to line power and turn on the instrument.

### CAUTION

Operating the instrument on an incorrect line voltage may cause damage to the instrument, possibly voiding the warranty.

*To turn a 2750 on and off:*

1. Verify that the line voltage shown in the window of the fuse holder assembly is correct for the operating voltage in your area. The window is shown in the following figure.

**Figure 1: 2750 power module**

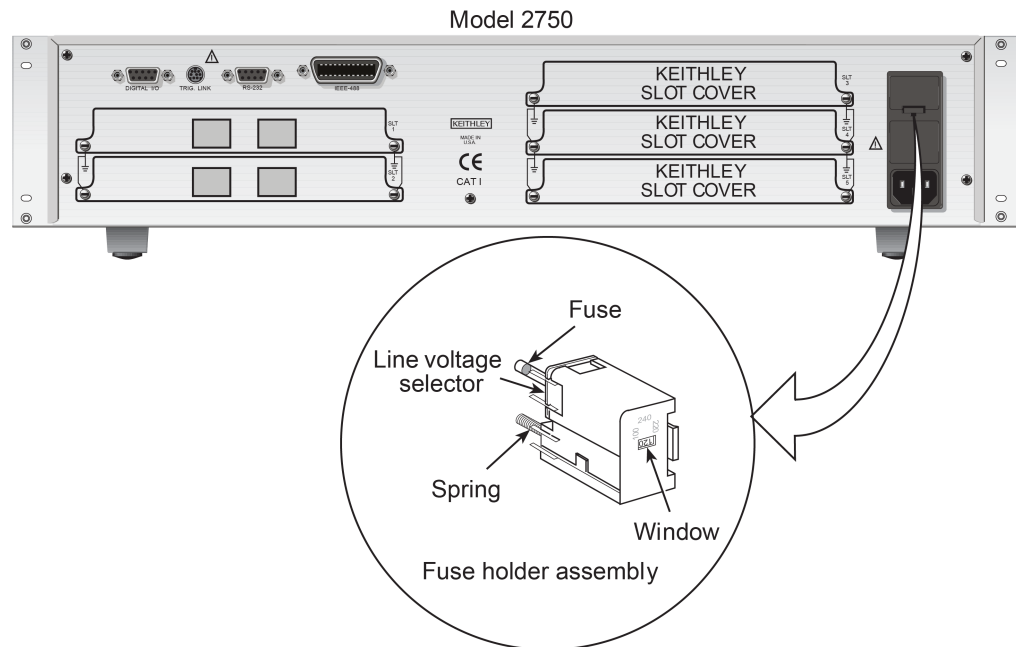

### NOTE

If the line voltage is not correct, refer to [Setting line voltage and replacing fuse](#) (on page 6-3).

2. Make sure that the front-panel POWER switch is in the off (O) position.
3. Connect the socket end of the supplied power cord to the AC receptacle on the rear panel.
4. Connect the other end of the power cord to a grounded AC outlet.

---

## WARNING

The power cord supplied with the 2750 contains a separate protective earth (safety ground) wire for use with grounded outlets. When proper connections are made, the instrument chassis is connected to power-line ground through the ground wire in the power cord.

---

5. To turn your instrument on, press the front-panel **POWER** switch to place it in the on (I) position.
6. To turn your instrument off, press the front-panel **POWER** switch to place it in the off (O) position.

## Power-up sequence

On power-up, the Model 2750 performs self-tests on its EPROM and RAM and momentarily lights all segments and annunciators. If a failure is detected, the instrument momentarily displays an error message and the ERR annunciator turns on. Error messages are listed in [Status and error messages](#) (on page 7-1).

If the instrument passes the self-tests, the firmware revision levels are displayed. An example of this display is:

```
REV: A01 A01
```

The first A01 is the main board ROM revision and the second A01 is the display board ROM revision.

The installed switching modules are then displayed. For example, if there is a Model 7700 switching module installed in all five slots, the following messages are displayed:

```
1: 7700 2: 7700  
3: 7700 4: 7700  
5: 7700
```

If a slot is empty, the message `NONE` is displayed instead.

If the saved power-on setup is not the factory defaults setup (`:SYSTem:POSetup PRESet`), a message to identify the setup is briefly displayed. Refer to [Defaults and user setups](#) (on page 2-6).

After the power-up sequence, the instrument begins its normal display of readings.

---

## NOTE

The serial number of the Model 2750 can be displayed by selecting the SNUM item of the SETUP menu. Press SHIFT and then SETUP to access the menu.

---

## Warmup period

After the Model 2750 is turned on, it must be allowed to warm up for at least two hours to allow the internal temperature to stabilize. If the instrument has been exposed to extreme temperatures, allow extra warmup time.

## Identifying installed switching modules

On power-up, the model numbers of installed switching modules are displayed briefly. While in the normal display state, slot indicators on the right side of the display indicate which slots have a switching module or pseudocard installed.

---

## NOTE

If a Model 7700, 7701, 7702, 7703, 7705, 7708, or 7709 switching module is removed while the Model 2750 is on, the slot indicator for that slot remains on and the instrument operates as if the module is installed. That is, the Model 2750 operates as if the pseudocard is installed.

If a Model 7706 or 7707 is removed while power is on, error +523, Card hardware error, occurs and the module is removed from the system.

In general, it is not recommended to install or remove switching modules with the power on.

---

You can use the CARD menu to identify modules installed in the mainframe.

## Keyclick

When keyclick is enabled, an audible click sounds when a front-panel key is pressed.

### *To disable or enable keyclick:*

1. Press **SHIFT** and then **LOCAL** to display the present state of KEYCLICK (ON or OFF).
2. Press **▲** or **▼** to display the keyclick state and press **ENTER**.

---

## NOTE

Keyclick ON is the default for FACTORY, \*RST, and :SYSTEM:PRESet.

---



## Display

Readings are displayed in engineering units, such as 100.23 mV, while annunciators indicate various states of operation. Refer to [Display annunciators](#) (on page 3-4) for a complete listing of display annunciators.

---

### NOTE

The display test allows you to test display digit segments, annunciators, and the red slot indicator LEDs. The key test checks the functionality of front-panel keys. To access these tests, press SHIFT and then TEST. Refer to the *Model 2750 Service Manual* for details.

---

## Status and error messages

Status and error messages are displayed momentarily. During operation and programming, you encounter a front-panel messages. Typical messages are either of status or error, as listed in [Status and error messages](#) (on page 7-1).

## Defaults and user setups

The 2750 can be restored to one of two default setup configurations (`FACTORY` or `*RST`), or three user-saved (`SAV0`, `SAV1`, or `SAV2`). As shipped from the factory, the 2750 powers up to the factory (`FACT`) default settings.

---

### NOTE

Closed channels can be saved in a user setup (`SAV0`, `SAV1`, or `SAV2`). When the setup is restored, those channels (and only those channels) are closed. The `FACT` and `*RST` defaults open all channels.

---

The factory default setup provides continuous triggering, while the `*RST` default setup places the 2750 in the one-shot trigger mode. With one-shot triggering, a measurement is made whenever the TRIG key is pressed or an initiate command is sent over the remote interface.

The factory and `*RST` default settings are listed in [Default settings](#) (on page 2-8).

For remote programming, the `SYSTEM:PRESet` and `*RST` commands reset the instrument. The `*RST` command returns the instrument to the `*RST` defaults. In most situations, the `SYSTEM:PRESet` command returns the instrument to the factory default conditions. The exceptions are:

- **Autoscan and autochannel configuration:** `FACTory` defaults disable autoscan and autochannel configuration. `SYSTEM:PRESet` has no effect. The `*RST` defaults (front-panel and remote operation) have no effect.
- **Memory buffer autoclear:** `FACTory` defaults enable buffer autoclear. `SYSTEM:PRESet` has no effect. The `*RST` defaults (front-panel and remote operation) have no effect.

The instrument powers up to whichever default setup is saved as the power-on setup.

---

## NOTE

At the factory, the factory default setup is saved as the `SAV0`, `SAV1`, or `SAV2` setup.

---

## Saving a user setup

*To save a user setup:*

1. Configure the 2750 for the measurement application.
2. Press `SHIFT` and then `SAVE` to access the save setup menu.
3. Press `▶` to place the cursor on the present setup (**`SAV0`**, **`SAV1`**, or **`SAV2`**).
4. Use the `▲` or `▼` key to display the setup and press `ENTER`. The instrument returns to the normal measurement state.

---

## CAUTION

If you make firmware upgrades, you lose all your saved settings.

---

## Saving a power-on setup

*To save a power-on setup:*

1. Configure the 2750 for the measurement application.
2. Press **`SHIFT`** and then **`SAVE`** to access the save setup menu.
3. Press the `▲` key to display the present power-on (PWR-ON) setup: **`FACT`**, **`*RST`**, **`SAV0`**, **`SAV1`**, or **`SAV2`**.
4. Press `▶` to place the cursor on the present power-on setup.
5. Use the `▲` or `▼` key to display the setup and press `ENTER`. The instrument returns to the normal measurement state.

## Restoring a setup

### To restore a setup:

1. Press **SHIFT** and then **SETUP** to access the restore setup menu.
2. Press **▶** to place the cursor on the present **RESTORE** setup (**FACT**, **\*RST**, **SAV0**, **SAV1**, or **SAV2**).
3. Use the **▲** or **▼** key to display the setup and press **ENTER**. The instrument returns to the normal measurement state.

## NOTE

If the settings for a user setup or power-on setup do not match the switching module types presently installed in the Model 2750, error +520, Saved setup scancard mismatch, occurs when the setup is recalled. The scan list resets to the factory defaults and all channels open. However, the saved setup is retained and can be restored if the matching switching module is later installed.

## Default settings

The Set Diff column indicates that there are differences between the Factory and \*RST default setups.

Setting	Factory	*RST	Set Diff
Autochannel configuration	No (off)	No effect	Yes
Autozero	On	On	
Buffer	No effect	No effect	
Autoclear	Yes (on)	No effect	Yes
Channel average	Off	Off	
Closed channels	None	None	
Closure count interval	No effect	No effect	
Continuity			
Beeper	On	On	
Digits	4½ digits	4½ digits	
Range	1 kΩ	1 kΩ	
Rate	Fast (0.1 PLC)	Fast (0.1 PLC)	
Threshold level	10 Ω	10 Ω	
Current (AC and DC)			
Bandwidth (AC)	30	30	
Digits (AC)	5½ digits	5½ digits	
Digits (DC)	6½ digits	6½ digits	
Filter	On	Off	Yes
Window	0.1%	0.1%	
Count	10	10	
Type	Moving	Repeat	Yes

Setting	Factory	*RST	Set Diff
Range	Auto	Auto	
Rate (DC)	Slow (5 PLC)	Slow (5 PLC)	
Rel	Off	Off	
Dry circuit ohms	Off	Off	
Frequency and Period			
Digits	6½ digits	6½ digits	
Range	10 V	10 V	
Rate (aperture)	1 second	1 second	
Rel	Off	Off	
Function	DCV		
GPIB	No effect	No effect	
Address	No effect (16 at factory)	No effect (16 at factory)	
Keyclick	On	On	
Limits	Off	Off	
LO Limit 1	-1	-1	
HI Limit 1	+1	+1	
LO Limit 2	-2	-2	
HI Limit 2	+2	+2	
Line Synchronization	Off	Off	
Math			
mX+B	Off	Off	
Scale Factor	1.0	1.0	
Offset	0.0	0.0	
Units	"X"	"X"	
Percent	Off	Off	
Reference	1.0	1.0	
1/X (Reciprocal)	Off	Off	
Monitor	Off	Off	
Output			
Beeper	Never	Never	
Digital Output	Off	Off	
Logic Sense	High	High	
Pulse	No (off)	No (off)	
Ratio	Off	Off	
Resistance ( $\Omega 2$ and $\Omega 4$ )			
Digits	6½ digits	6½ digits	
Filter	On	Off	Yes
Window	0.1%	0.1%	
Count	10	10	
Type	Moving	Repeat	3
Offset compensation (OCOMP)	Off	Off	
Dry circuit	Off	Off	
Range	Auto	Auto	
Rate	Slow (5 PLC)	Slow (5 PLC)	
Rel	Off	Off	
RS-232	Off	Off	
Baud rate	No effect	No effect	
Flow control	XonXoFF	XonXoFF	
Terminator	No effect	No effect	

Setting	Factory	*RST	Set Diff
Scanning	Disabled	Disabled	
Autoscan	No (off)	No effect	Yes
Type (Simple or Advanced)	No effect	No effect	
Simple scan			
Minimum channel	101, 201, 301, 401, or 501	101, 201, 301, 401, or 501	
Maximum channel	No effect	No effect	
Timer	Off	Off	
Reading count	No effect	No effect	
Advanced scan			
Setup	No effect	No effect	
Immediate trigger	On	On	
Limit triggers	Off	Off	
Timer	Off	Off	
Reading count	No effect	No effect	
Temperature			
Digits	5½ digits	5½ digits	
Filter	On	Off	Yes
Window	0.1%	0.1%	
Count	10	10	
Type	Moving	Repeat	Yes
Rate	Slow (5 PLC)	Slow (5 PLC)	
Rel	Off	Off	
Sensor	Thermocouple	Thermocouple	
Junction	See Note	See Note	
Open detector	No (off)	No (off)	
Type	K	K	
Units	°C	°C	
Timestamp	No effect	No effect	
Triggering	Continuous	One-shot	Yes
Delay	Auto	Auto	
Source	Immediate	Immediate	
Voltage (AC and DC)			
dB	Off	Off	
Reference	1.0	1.0	
Digits (AC)	5½ digits	5½ digits	
Digits (DC)	6½ digits	6½ digits	
Filter	On	Off	Yes
Window	0.1%	0.1%	
Count	10	10	
Type	Moving	Repeat	Yes
Range	Auto	Auto	
Rate (DC)	Slow (5 PLC)	Slow (5 PLC)	
Rel	Off	Off	

## NOTE

With a Model 7700, 7706, or 7708 installed, the default sensor junction is Internal. Otherwise, the Simulated (23°C) junction is selected.

## Instrument description

### In this section:

Front panel.....	3-1
Rear panel.....	3-5

## Front panel

The front panel of the 2750 is shown in the following figure.

**Figure 2: 2750 front panel**

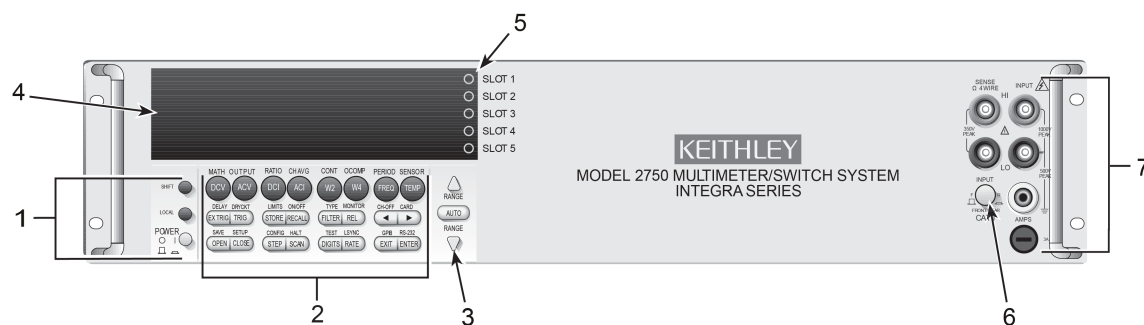

## NOTE

Most keys provide a dual function or operation. The nomenclature on a key indicates its unshifted function/operation, which is selected by pressing the key. Nomenclature above a key indicates its shifted function. A shifted function is selected by pressing the SHIFT key and then the function or operation key.

## 1 Special keys and power switch

SHIFT	Use to select a shifted function or operation.
LOCAL	Cancels GPIB remote mode.
POWER	Power switch. In position turns the 2750 on (I), and the out position turns it off (O).

## 2 Function and operation keys

### Top row

Unshifted	
DCV	Selects DC voltage measurement function.
ACV	Selects AC voltage measurement function.
DCI	Selects DC current measurement function.
ACI	Selects AC current measurement function.
$\Omega 2$	Selects 2-wire resistance measurement function.
$\Omega 4$	Selects 4-wire resistance measurement function.
FREQ	Selects frequency measurement function.
TEMP	Selects temperature measurement function.
Shifted	
MATH	Configures and controls mX+b, percent, or reciprocal (1/X) calculation.
OUTPUT	Configures and controls digital and audio (beeper) output for limits.
RATIO	Enables or disables channel ratio.
CH-AVG	Enables or disables channel average.
CONT	Configures and controls continuity test.
OCOMP	Enables or disables offset compensated ohms with $\Omega 4$ function selected.
PERIOD	Selects period measurement function.
SENSOR	Configures temperature measurements.

### Middle row

Unshifted	
EX TRIG	Selects external triggering (front panel, bus, trigger link) as the trigger source.
TRIG	Triggers a measurement when in external triggering (EX TRIG).
STORE	Sets the number of readings to store and enables the buffer.
RECALL	Displays stored readings and buffer statistics. Use the ◀, ▶, ▲, and ▼ keys to navigate through the buffer.
FILTER	Enables or disables filter for selected function.
REL	Enables or disables relative for selected function.
◀ and ▶	Dual function. Manually scans switching channels. In a menu, these keys control cursor position for making selections or change values.

Shifted	
<b>DELAY</b>	Sets user delay between trigger and measurement.
<b>DRYCKT</b>	Selects dry circuit ohms ( $\Omega 4$ must first be selected).
<b>LIMIT</b>	Sets upper and lower limits for readings.
<b>ON/OFF</b>	Enables or disables limits.
<b>TYPE</b>	Configures and enables filter for selected function.
<b>MONITOR</b>	Selects and enables or disables monitor channel.
<b>CH-OFF</b>	Disables channel for a scan (must be in scan channel setup mode).
<b>CARD</b>	Identifies switching modules installed in mainframe. Set up switching modules that require configuration. View closed channels and channel settings for switching modules that require configuration.

### Bottom row

Unshifted	
<b>OPEN</b>	Opens closed channel.
<b>CLOSE</b>	Closes specified channel.
<b>STEP</b>	Steps through channels; sends a trigger after each channel.
<b>SCAN</b>	Scans through channels; sends a trigger after last channel.
<b>DIGITS</b>	Sets display resolution for all functions.
<b>RATE</b>	Sets measurement speed (fast, medium, or slow) for all functions.
<b>EXIT</b>	Cancels selection, moves back to measurement display.
<b>ENTER</b>	Accepts selection, moves to next choice or back to measurement display.
Shifted	
<b>SAVE</b>	Saves up to three instrument setups for future recall, and selects power-on setup.
<b>SETUP</b>	Restores a default setup (factory or *RST) or a saved setup. Enables or disables buffer autoclear, autoscan, and autochannel configuration. Sets timestamp, date, and time. Displays serial number of Model 2750.
<b>CONFIG</b>	Selects and configures a simple scan or an advanced scan.
<b>HALT</b>	Disables step or scan.
<b>TEST</b>	Selects the calibration menu, display test or the keypress test.
<b>LSYNC</b>	Enables or disables line cycle synchronization. When enabled, noise induced by the power line is reduced at the expense of speed.
<b>GPIB</b>	Enables or disables GPIB and selects address.
<b>RS-232</b>	Enables or disables the RS-232 interface; selects baud rate, flow control, and terminator.

## 3 Range keys

<b>▲ and ▼</b>	Dual function. Selects the next higher or lower measurement range for the selected function. In a menu, these keys make selections or change values.
<b>AUTO</b>	Enables or disables autorange for the selected function.



## 4 Display annunciators

*	Readings are being stored in the buffer.
<->	Indicates additional selections are available.
)))	Beeper on for continuity or limits testing. Digital input/output or analog output active (set to non-default value).
4W	4-wire resistance or 4-wire RTD temperature reading displayed.
DCKT	Dry circuit resistance reading displayed.
~AC	AC function selected (ACV, dB, or ACI).
AUTO	Automatic source range is enabled.
BUFFER	Recalling readings stored in buffer.
CHAN	Setup or a reading for a switching channel displayed.
DELTA	Channel average enabled.
ERR	Questionable reading or invalid calibration step.
FAST	Fast reading rate selected.
FILT	Filter enabled for selected function.
HIGH	Reading has reached or exceeded the enabled high limit.
LSTN	Instrument is addressed to listen.
LOW	Reading has reached or exceeded the enabled low limit.
MATH	mX+b, percent, or reciprocal (1/X) calculation enabled.
MED	Medium reading rate selected.
MON	Monitor channel displayed.
OCOMP	4-wire offset compensated ohms enabled.
RATIO	Channel ratio enabled.
REAR	Front-panel input terminals disconnected.
REL	Relative enabled for selected function.
REM	Instrument is in remote mode.
SCAN	Scanning operation being performed.
SHIFT	Accessing a shifted key.
SLOW	Slow reading rate selected.
SRQ	Service request.
STAT	Displaying buffer statistics.
STEP	Stepping operation being performed.
TALK	Instrument addressed to talk.
TIMER	Timer controlled triggering in use.
TRIG	External triggering is selected (trigger link, TRIG key, or GPIB).

## 5 Slot indicators

Lighted lamp indicates that the slot has a switching module or pseudocard installed. When the VIEW option of the CARD menu is used, only the lamp that corresponds to the selected slot is lighted.

## 6 INPUTS switch

Use to select inputs. Out position (O) selects the front panel, and the in position (I) selects the switching module inputs.

## 7 Front-panel inputs

<b>INPUT HI and LO</b>	Use for DCV, ACV, $\Omega$ , CONT, FREQ, PERIOD, thermocouple TEMP and thermistor TEMP measurements.
<b>SENSE HI and LO</b>	Use for INPUT HI and LO for $\Omega$ and RTD TEMP measurements.
<b>AMPS</b>	Use for INPUT LO for DCI and ACI measurements.
<b>Amps fuse holder</b>	Holds the current fuse for front-panel amps input.

## Rear panel

The rear panel of Model 2750 is shown in the following figure. As shown, slot covers are installed on unused slots.

---

### **WARNING**

**Slot covers must be installed on unused slots to prevent personal contact with high-voltage circuits. Failure to recognize and observe standard safety precautions could result in personal injury or death due to electric shock.**

---

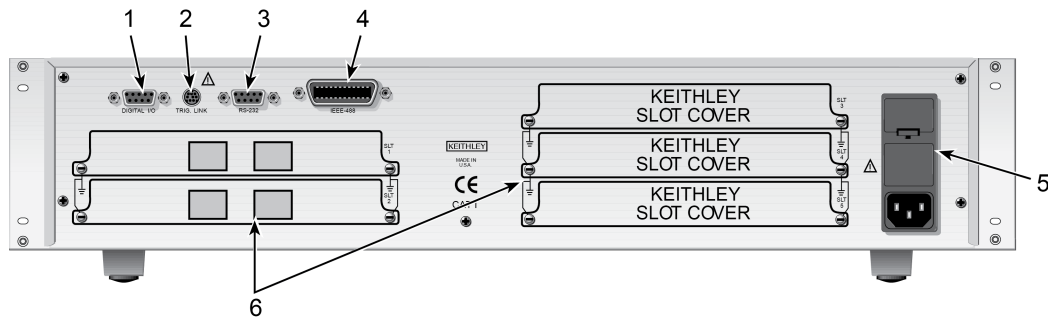
**Figure 3: 2750 rear panel****1 DIGITAL I/O**

Male DB-9 connector for digital input (trigger link in) and digital outputs.

**2 TRIG LINK**

Eight-pin micro-DIN connector for sending and receiving trigger pulses among connected instruments. Use a trigger link cable or adapter.

**3 RS-232**

Female DB-9 connector for RS-232 operation. Use a straight-through (not null modem) DB-9 shielded cable.

**4 IEEE-488**

Connector for IEEE-488 (GPIB) operation. Use a shielded cable.

**5 Power module**

Contains the AC line receptacle, power line fuse, and line voltage setting. The instrument can be configured for line voltages of 100 VAC, 120 VAC, 220 VAC, and 240 VAC at line frequencies of 50 Hz or 60 Hz.

**6 Slots 1 through 5**

Five slots to accommodate Keithley Model 77XX series switching modules. The Model 2750 is shipped from the factory with slot covers installed. Additional slot covers can be requested from Keithley Instruments.

**In this section:**

Introduction .....	4-1
Basic DMM operation .....	4-7
Range .....	4-40
Relative offset .....	4-41
Rate .....	4-42

## Introduction

---

** WARNING**

Before operating an instrument with a switching module, verify that the switching module is properly installed and the mounting screws are tightly fastened. If the mounting screws are not properly connected, an electrical shock hazard may be present.

---

This section summarizes the following basic instrument operations and provides simple exercises to perform them:

- **Basic DMM measurements:** Front-panel inputs
- **Closing and opening channels:** System channel operation
- **Simple scanning**

---

** WARNING**

For the exercises, you do not need to connect an input signal or DUT to the instrument through the (front-panel inputs or switching module inputs. However, if you decide to use an input signal, it is recommended that you keep it at a nonhazardous level (< 42 V) while learning to use the instrument.

---

---

**NOTE**

When using the front-panel input terminals, the **INPUT** switch must be in the F (out) position. The switch is on the right side of the front panel near the input terminals. When using a switching module, the switch must be in the R (in) position.

---

## Basic DMM measurements using front-panel inputs

When shipped from the factory, the 2750 is set to continuously measure DC volts. Some default settings for the DCV function include autorange enabled, 6½-digit resolution, filter enabled, and slow reading rate. These settings provide a basic starting point and, in many cases, do not need to be changed. Default settings are also provided for the other measurement functions.

To perform basic measurements, select the function, then adjust the setup, such as range, rate, filter, and digits settings.

For remote programming, the instrument is typically used in a non-continuous measurement mode. In this mode, the user uses remote commands to specify the number of measurements to perform. \*RST defaults place the instrument in a non-continuous measurement mode. Most of the other settings for factory and \*RST defaults are the same.

### Exercise 1: Basic DMM measurements

The following exercise measures AC voltage on the 10 V range and stores 15 readings in the buffer.

***To make a DMM measurement:***

1. Press the **SHIFT** key
2. Press the **SETUP** key.
3. Select **RESTORE: FACT**. This restores the instrument to the factory defaults.
4. Press **ACV** to select the AC voltage function.
5. Press **RANGE ▲** to display **RANGE: 10V**. This selects the 10 V range.
6. Press the **STORE** key to set the number of readings to store in the buffer.
7. Select **000015 RDGS**.
8. Press the **ENTER** key.
9. Press the **RECALL** key and use the edit keys to display the readings.
10. Press the **EXIT** key to close recall mode.

## Closing and opening channels using system channel operation

The following discussion assumes a multiplexing switching module, such as a 7700, installed in slot 1 of the mainframe. Switching module installation is described in [Switching module installation and connections](#) (on page 2-1).

System channel operation is used to connect input channels to the DMM of the 2750.

For a 2-wire function such as DCV, closing a system channel connects the input to DMM Input of the 2750.

The following figure shows system channel 1 closed. For the  $\Omega 2$  function, the resistance (DUT) is connected to DMM Input.

**Figure 4: Connection to DMM for 2-wire function (system channel 101 closed)**

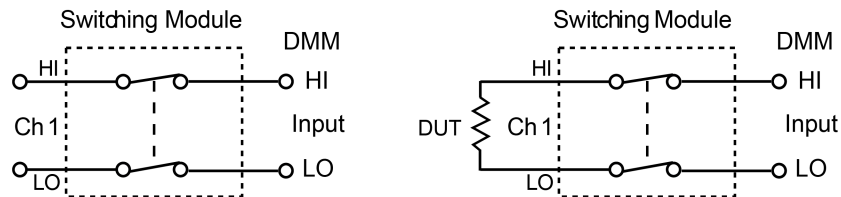

For a 4-wire function such as  $\Omega 4$ , a channel pair is connected to the DMM when a system channel is closed. The system channel is connected to DMM Input and the paired channel is connected to DMM Sense. The following figure shows system channel 6 closed and how the DUT is connected to the DMM for the 4-wire function. For a 4-wire function, the paired channel also closes. For the Model 7700, channels 1 through 10 are paired to channels 11 through 20. When channel 6 is closed, channel 16 also closes.

**Figure 5: Connection to DMM for 4-wire function (system channel 106 closed)**

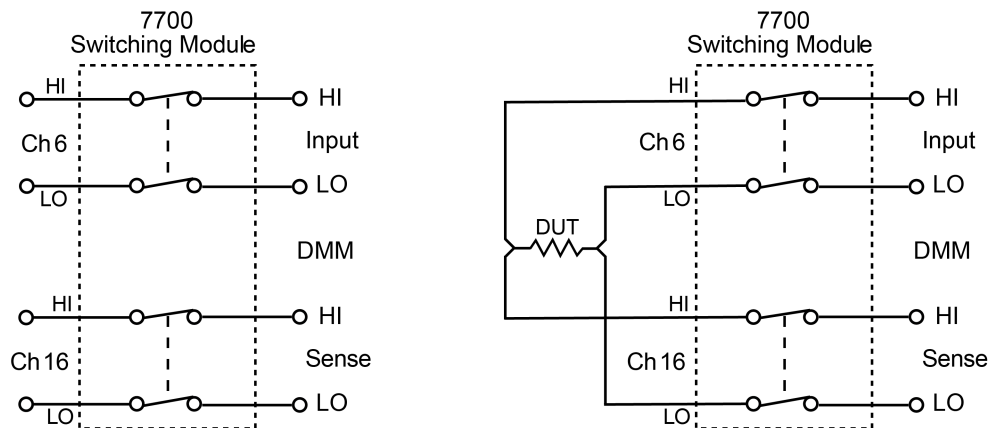

## NOTE

The figures in this topic show simplified schematics of the switching module. They show that a single switch is closed to connect an input channel to the DMM. Multiple switching is used to make proper connections to the DMM. However, for system channel operation, the user does not need to be concerned about which switches in the module close.

### Close and open operation

The following points on operation pertain to system channel operation only:

- Only one input channel (or channel pair) is closed at one time. When you close an input channel, the previously closed input channels open.
- When a system channel is closed, the channel number is displayed on the 2750. The slot number for the module is also displayed. For example, 103 indicates that system input channel 3 for a module in slot 1 is closed.
- The paired channel for a 4-wire function is not displayed. Only the system channel number is displayed. For example, in the figure “Connection to DMM for 4-wire function (system channel 106 closed)”, 106 is displayed with the Model 7707 installed in slot 1 of the mainframe.
- Switching modules that have current measurement capability have separate channels reserved exclusively for the DCI and ACI functions. For example, the Model 7700 has channels 21 and 22 reserved for amps measurements. With the DCI or ACI function selected, only channels 21 and 22 can be closed. These channels cannot be accessed from any other function.

The following figure shows the front-panel keys used to close and open system channels.

**Figure 6: Front-panel keys to close and open system channels**

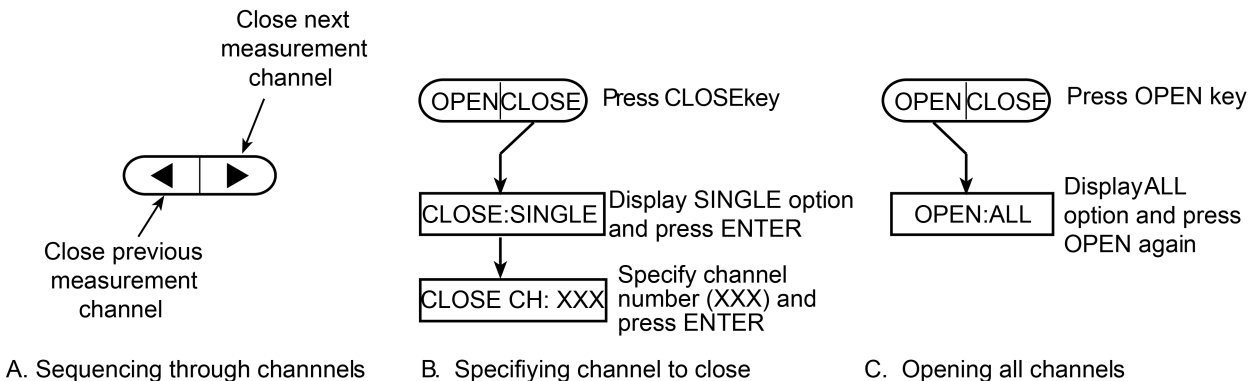

## Exercise 2: Closing and opening channels (system channel operation)

The following exercise demonstrates a sequence to close and open channels of a Model 7700 installed in slot 1 of the mainframe.

---

### NOTE

It is a good safe practice to start and end a switching sequence by opening all channels.

---

---

### NOTE

If you are an inexperienced user, it is recommended that you do not connect DUT and external circuitry to switching modules when performing these exercises. This allows you to exercise close and open operations without the dangers associated with live test circuits.

---

#### ***To open and close channels:***

1. To open all channels, press **OPEN**, select display **OPEN:ALL**, then press **OPEN**.
2. Press **Ω2** to select the Ω2 function.
3. Press the ► key to close the system channel 101. Channel 1 connects to DMM Input.
4. Press the ► key to close system channel 102. Channel 2 connects to DMM Input.
5. Press **CLOSE**, select **CLOSE:SINGLE**, enter channel 106, then press **ENTER**. Channel 6 connects to DMM Input, and system channel 106 closes.
6. Press **Ω4** to select the Ω4 function. The 4Ω annunciator turns on and channels 6 and 16 connect to the DMM Input and Sense.
7. To open all channels, press **OPEN**, select display **OPEN:ALL**, then press **OPEN**.

## Simple scanning

---

### NOTE

Refer to the *Model 2750 Reference Manual* for details on scanning.

---

With at least one multiplexer switching module, such as a 7700, installed in the mainframe, the instrument can scan channels that are valid for the selected function.

The following figure shows the basic steps to configure and run a simple scan. The differences between the STEP function and the SCAN function involve the reading count and the timer.



**Reading count (RDG CT):** For both STEP and SCAN, the reading count specifies the number of readings to store in the buffer. For STEP, the reading count determines the number of channels to scan.

For SCAN, the reading count also determines the number of scans to perform. For example, assume the scan list includes 10 channels, 101 through 110, in the scan list. If you set the reading count to 10 or less, one scan of the 10 channels is performed. If you set the reading count to any value from 11 to 20, two scans are performed. A reading count from 21 to 30 gives you three scans, and so on.

**Timer interval (TIMER):** For the STEP function, the timer specifies the time delay between scanned channels. For the SCAN function, the interval specifies the time delay between scans. The timer starts when the scan is started. For SCAN, the next scan does not start until the timer interval expires.

**Figure 7: Simple scan operation**

Step 1. Configure simple scan:

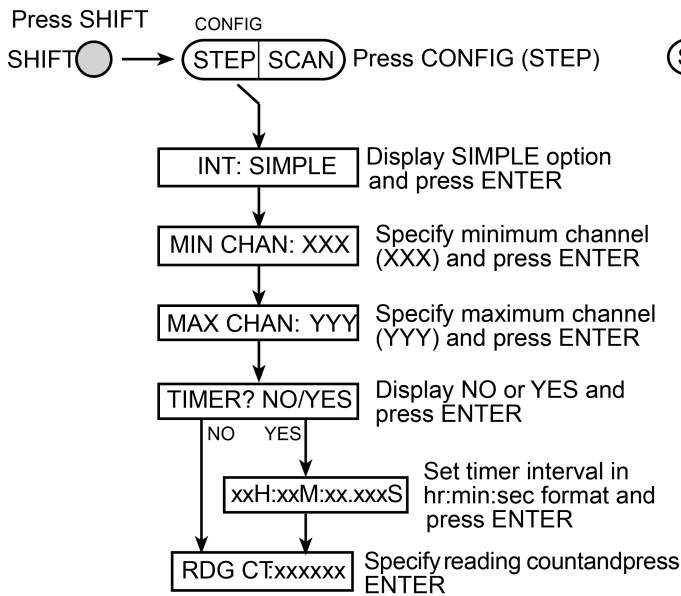

Step 2. Run simple scan:

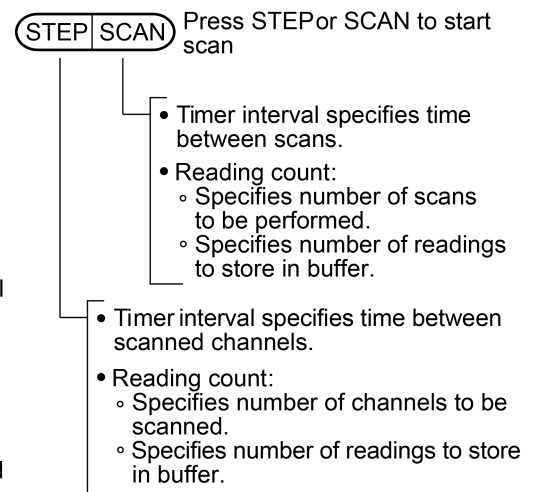

Step 3. Disable scan mode:

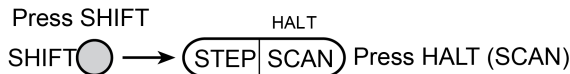

### Exercise 3: Simple scanning

The scanning example in the following steps assumes a Model 7700 installed in slot 1 of the mainframe. The scan uses the factory default settings (DCV) to scan eight channels and store the readings in the buffer. Factory reset opens all channels, selects the DCV function, and sets the trigger count to 1. The trigger count specifies the number of scans to be done.

***To run a simple scan:***

1. To restore the defaults, press **SHIFT**, press **SETUP**, and select **RESTORE: FACT**.
2. To configure the scan, press **SHIFT**, press **CONFIG**, and select **INT: SIMPLE**
3. Set **MIN CHAN 101**
4. Set **MAX CHAN: 108**
5. Select **TIMER? NO** and set **RDG CT:000008**
6. To enable and start the scan, press **STEP**.
7. To halt the scanner, press **SHIFT**, then press **HALT**.
8. To recall the eight stored readings, press **RECALL** and use the edit keys to display the readings. Press **EXIT** to exit recall mode.
9. To open all channels, press **OPEN**, display **OPEN:ALL**, then press **OPEN**.

## Basic DMM operation

- **DMM measurement capabilities (on page 4-8):** Summarizes the measurement capabilities of the Model 2750 and covers maximum signal levels for switching modules.
- **High energy circuit safety precautions (on page 4-9):** Provides safety information when performing measurements in high energy circuits.
- **Voltage measurements (DCV and ACV) (on page 4-10):** Provides detailed information for making basic DC and AC voltage measurements.
- **Current measurements (DCI and ACI) (on page 4-14):** Provides detailed information for making basic DC and AC current measurements.
- **Resistance measurements (on page 4-16):** Provides detailed information for making resistance measurements. Also covered are offset compensated ohms (OCOMP) and dry circuit ohms (DRYCKT).
- **Temperature measurements (on page 4-25):** Provides detailed information for making thermocouple, thermistor, and 4-wire RTD temperature measurements.
- **Frequency and period measurements (on page 4-36):** Provides detailed information for making frequency and period measurements.
- **Continuity testing (on page 4-39):** Explains how to use the CONT feature to test continuity.

## DMM measurement capabilities

The DMM of the Model 2750 can make the following measurements:

- **DCV:** DC voltage measurements from 0.1  $\mu$ V to 1000 V.
- **ACV:** AC voltage measurements from 0.1  $\mu$  V to 750 V.
- **DCI:** DC current measurements from 10 nA to 3 A.
- **ACI:** AC current measurements from 1  $\mu$ A to 3 A.
- **$\Omega$ 2:** 2-wire resistance measurements from 10  $\mu\Omega$  to 120 M $\Omega$ .
- **$\Omega$ 4:** 4-wire resistance measurements from 1  $\mu\Omega$  to 120 M $\Omega$
- **FREQ:** Frequency measurements from 3 Hz to 500 kHz.
- **PERIOD:** Period measurements from 333 ms to 2  $\mu$ s.
- **TEMP:** Temperature measurements from -200  $^{\circ}$ C to 1820  $^{\circ}$ C.
- **CONT:** Continuity testing using the 1 k $\Omega$  range.

---

### CAUTION

**When using a switching module, do not exceed the maximum signal levels of the module. Refer to the specifications for the switching module for the maximum signal levels.**

---

---

### NOTE

The following topics show DUT connections to the front-panel inputs of the Model 2750 and to the Model 7700 switching module. Refer to the Model 7700 documentation for additional information.

---

## High energy circuit safety precautions

To optimize safety when measuring voltage in high energy distribution circuits, read and use the directions in this topic.

---

### **WARNING**

**Dangerous arcs of an explosive nature in a high energy circuit can cause severe personal injury or death. If the multimeter is connected to a high energy circuit when set to a current range, low resistance range, or any other low impedance range, the circuit is virtually shorted. Dangerous arcing can result even when the multimeter is set to a voltage range if the minimum voltage spacing is reduced in the external connections.**

**As described in the International Electrotechnical Commission (IEC) Standard IEC 664, the Model 2750 is Installation Category I and must not be connected to mains.**

---

When making measurements in high-energy circuits, use test leads that meet the following requirements:

- Test leads should be fully insulated.
- Only use test leads that can be connected to the circuit (for example, alligator clips and spade lugs) for hands-off measurements.
- Do not use test leads that decrease voltage spacing. These diminish arc protection and create a hazardous condition.

---

### **WARNING**

**For the front-panel inputs, the maximum common-mode voltage (the voltage between INPUT LO and chassis ground) is 500 V<sub>PEAK</sub>. For a switching module, the maximum common mode voltage is 300 V. Exceeding these values may cause a breakdown in insulation that can create a shock hazard.**

---

**To test power circuits:**

1. De-energize the circuit using the regular installed connect-disconnect device. For example, remove the power cord from the device or turn off the power switch.
2. Attach the test leads to the circuit under test. Use appropriate safety rated test leads for this application. If over 42 V, use double insulated test leads or add an additional insulation barrier for the operator.
3. Set the multimeter to the proper function and range.
4. Energize the circuit using the installed connect-disconnect device and make measurements without disconnecting the multimeter.
5. De-energize the circuit using the installed connect-disconnect device.
6. Disconnect the test leads from the circuit under test.

**Voltage measurements (DCV and ACV)**

The Model 2750 can make DCV measurements from 0.1  $\mu\text{V}$  to 1000 V and ACV measurements from 0.1  $\mu\text{V}$  to 750  $V_{\text{RMS}}$ , 1000  $V_{\text{PEAK}}$ .

<b>DCV input resistance</b>	100 V and 1000 V ranges: 10 $\text{M}\Omega$ 100 mV, 1 V, and 10 V ranges: $> 10 \text{ G}\Omega \parallel < 400 \text{ pF}$ or 10 $\text{M}\Omega$
<b>ACV input impedance</b>	1 $\text{M}\Omega \parallel < 100 \text{ pF}$

**Connections**** WARNING**

Even though the Model 2750 can measure up to 1000  $V_{\text{PEAK}}$ , the maximum input to a switching module is less. Exceeding the voltage rating of a switching module may cause damage and create a safety hazard.

**NOTE**

Make sure the INPUTS switch is in the correct position. To use front-panel inputs, it must be in the F (out) position. For switching modules, it must be in the R (in) position.

To achieve a stable reading, it helps to shield resistances greater than 100  $\text{k}\Omega$ . As shown in the figures in [Front-panel inputs](#) (on page 4-17) and [Model 7700 connections for resistance measurements](#) (on page 4-18), place the resistance in a shielded enclosure and connect the shield to the input low terminal of the instrument electrically.

For high resistance measurements in a high humidity environment, use Teflon<sup>TM</sup> insulated cables to minimize errors due to cable leakage.

### Front-panel inputs

When using the front-panel input terminals, connect the test leads to the INPUT HI and LO terminals as shown in the following figure.

**Figure 8: DCV and ACV connections using front-panel inputs**

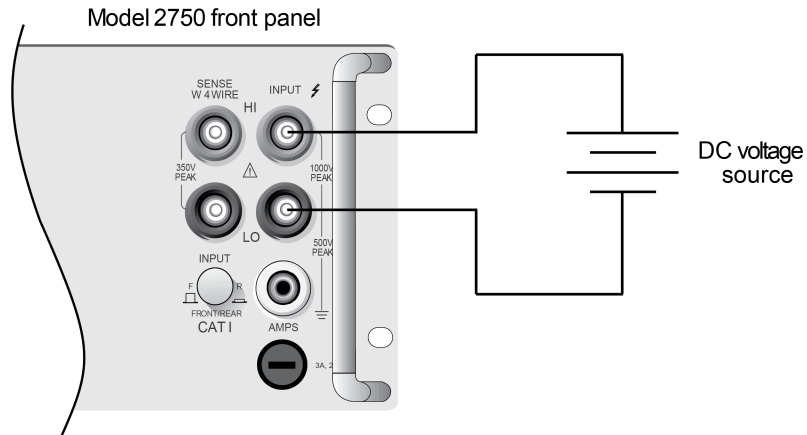

Input Resistance = 10 MΩ on 1000 V and 100 V ranges;  
 >10 GΩ on 10 V, 1 V, and 100 mV ranges.

Caution: Maximum input = 1000 V peak

A. DCV connections

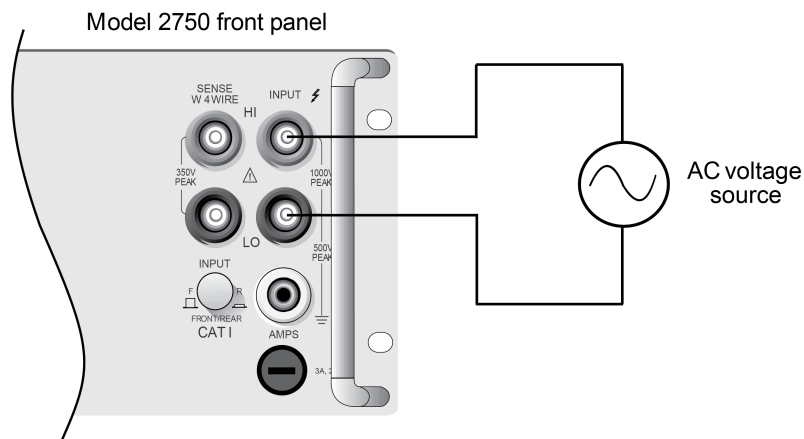

Input impedance = 1 MΩ || < 100 pF

Caution: Maximum input = 750 V RMS, 1000 V peak, 8 x 10<sup>7</sup> VHz

B. ACV connections

### Model 7700 connections for voltage measurements

Connections for the Model 7700 switching module are shown in the following figure. For basic DCV and ACV measurements, channels 1 through 20 can be used.

You can use ratio and channel average calculations on voltage measurements. Ratio calculates the reading ratio of two channels, while channel average calculates the reading average of two channels. For these calculations, paired switching channels are used. Primary channels 1 through 10 are paired to channels 11 through 20 (channel 1 paired to channel 11, channel 2 paired to channel 12, and so on), as shown in C in the figure. For ratio and channel average connections (DCV), one DC voltage source is connected to a primary channel (for example, 104), and the other source is connected to its paired channel (for example, 114).

## NOTE

The ratio and channel average calculations are described in the *Model 2750 Reference Manual*.

**Figure 9: DCV and ACV connections using the Model 7700 switching module**

Caution: Maximum input: 300 VDC or RMS, 1 A switched, 60 W, 125 VA maximum

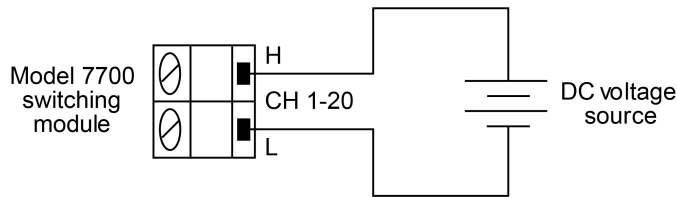

A. DCV connections

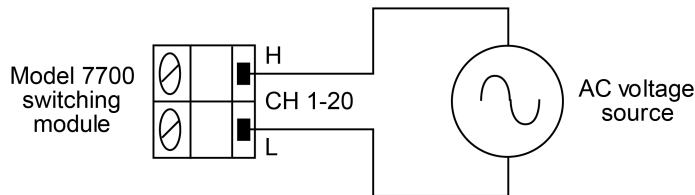

B. ACV connections

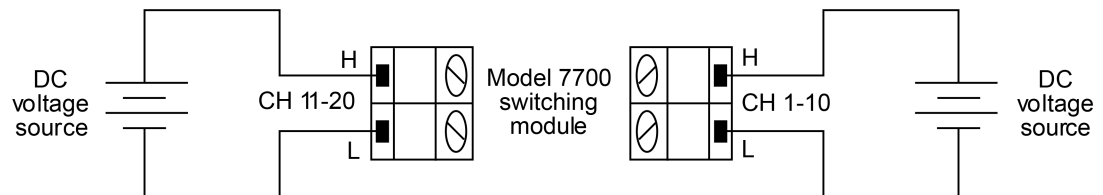

C. Ratio and channel average connections (DCV)

Note: The low connections for channels 1 through 10 do not need to be referenced to the low connections for channels 11 through 20.

## Volts measurement procedure

---

### CAUTION

Do not apply more than maximum input levels indicated in [Front-panel input](#) (on page 4-11) and [Model 7700 switching module](#) (on page 4-11) or instrument damage may occur. The voltage limit is subject to the  $8 \times 10^7$  VHz product. For the Model 7700 switching module, the maximum allowable voltage is 300 VDC or  $V_{RMS}$ . Exceeding these limits may cause damage to the switching module.

---







---

### WARNING

If both the front-panel terminals and the switching module terminals are connected at the same time, the test leads must be rated to the highest voltage that is connected. For example, if 1000 V is connected to the front-panel input, the test lead insulation for the switching module must also be rated for 1000 V. Failure to use properly rated test leads could result in exposure to electrical shock that could result in personal injury or death.



---

#### *To measure voltage using the front panel:*

1. If a switching channel is presently closed (displayed), press **OPEN** to open it.
2. Select the volts measurement function by pressing **DCV** or **ACV**.
3. Use the **RANGE**  and  keys to select a measurement range consistent with the expected voltage, or press **AUTO** to select autoranging (the **AUTO** annunciator turns on).
4. Apply the voltages to be measured.
5. If you are using a switching module, close the channel. Press the **CLOSE** key and use , , , and  to key in the channel number and press **ENTER**. The previously closed channel (if there is one) opens and the specified channel closes.
6. Observe the displayed reading. If the **OVERFLOW** message is displayed, select a higher range until a normal reading is displayed (or press **AUTO** for autoranging). For manual ranging, use the lowest possible range for the best resolution.
7. To measure other switching channels, repeat steps 5 and 6.
8. When finished, press **OPEN** if there is a channel closed.

---

### NOTE

In the normal measurement state, you can use the  and  keys to close channels. In general, each key press opens the presently closed channel, and then closes the next higher or lower channel.

---



## Current measurements (DCI and ACI)

The Model 2750 can make DCI measurements from 10 nA to 3 A and ACI measurements from 1  $\mu$ A to 3 A<sub>RMS</sub>.

### Front-panel input connections

When using the front-panel input terminals, connect the test leads to the AMPS and INPUT LO terminals as shown in the following figure.

**Figure 10: DCI and ACI connections using front-panel inputs**

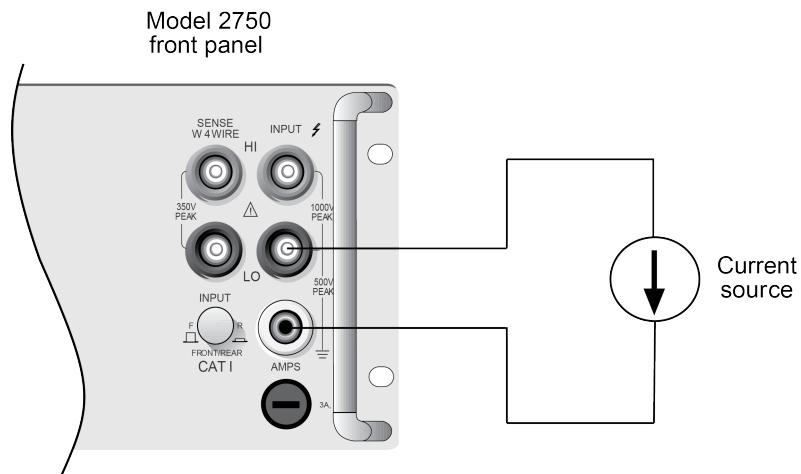

Caution: Maximum input = 3 A DC or RMS

### Model 7700 connections for current measurements

Connections for the Model 7700 switching module are shown in the following figure. Only channels 21 and 22 can be used for current measurements.

**Figure 11: DCI and ACI connections using the Model 7700 switching module**

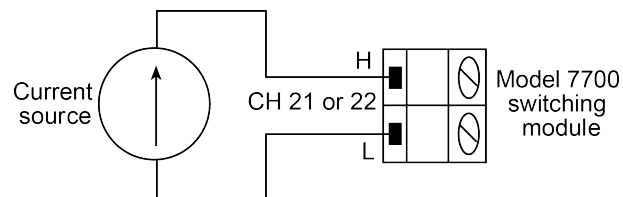

Caution: Maximum input: 60 V DC or 30 V RMS, 3 A  
60 W, 125 VA maximum

## Current measurement procedure

---

### CAUTION

Do not apply more than 3 A to the input. Applying excessive current to the input will cause the AMPS fuse to blow.

---

---

### CAUTION

If you are using the Model 7700 switching module, the maximum allowable voltage is 60 VDC or 30 V<sub>RMS</sub>. Exceeding these limits could cause damage to the switching module.

---

#### *To make a current measurement:*

1. If a switching channel is presently closed (displayed), press **OPEN** to open it.
2. Select the amps measurement function by pressing **DCI** or **ACI**.
3. Use the **RANGE ▲** and **▼** keys to select a measurement range consistent with the expected current or press **AUTO** to select autoranging (**AUTO** annunciator turns on).
4. Apply the currents to be measured.
5. If using a switching module, use the **▲** and **▼** keys to close the amps channel (channels 21 or 22 on the Model 7700). All other channels are open.
6. Observe the displayed reading. If the **OVERFLOW** message is displayed, select a higher range until a normal reading is displayed or press **AUTO** to use autoranging). For manual ranging, use the lowest possible range for the best resolution.
7. To measure another amps channel, repeat steps 5 and 6.
8. When finished, press **OPEN** if there is a channel closed.

---

### NOTE

When you have an amps-only channel closed, you cannot select a non-amps function. For example, if channel 21 of the Model 7700 is closed, you cannot select the DCV function and **INVALID FUNC** is displayed.

---

## Resistance measurements ( $\Omega 2$ and $\Omega 4$ )

The Model 2750 uses the constant-current method to measure resistance from 1  $\Omega$  to 1 M $\Omega$ . The Model 2750 sources a constant current (I) to the resistance and measures the voltage (V). Resistance (R) is then calculated (and displayed) using the known current and measured voltage ( $R = V/I$ ). For the 10 M $\Omega$  and 100 M $\Omega$  ranges, the ratiometric method is used to measure resistance.

**Standard resistance measurements:** The Model 2750 can make resistance measurements from 1  $\mu\Omega$  to 120 M $\Omega$ . For resistances  $>1$  k $\Omega$ , the 2-wire ( $\Omega 2$ ) method is typically used for measurements. For resistances  $\leq 1$  k $\Omega$ , the 4-wire ( $\Omega 4$ ) measurement method should be used to cancel the effect of test lead (and channel path) resistances.

**Offset compensated ohms (OCOMP):** The presence of thermal EMFs (voltages) can adversely affect low-resistance measurement accuracy. To overcome these unwanted offset voltages, you can use offset-compensated ohms on the 1  $\Omega$ , 10  $\Omega$ , 100  $\Omega$ , 1 k $\Omega$ , and 10 k $\Omega$  ranges for the  $\Omega 4$  function.

**Dry circuit testing (DRYCKT):** For low-resistance measurements that require low open-circuit voltage (20 mV), dry circuit ohms can be used on the 1  $\Omega$ , 10  $\Omega$ , 100  $\Omega$ , and 1 k $\Omega$  ranges for the  $\Omega 4$  function.

## Connections

---

### WARNING

Even though the Model 2750 can measure up to 1000  $V_{PEAK}$ , the maximum input to a switching module is less. Exceeding the voltage rating of a switching module may cause damage and create a safety hazard.

---

### NOTE

Make sure the INPUTS switch is in the correct position. To use front-panel inputs, it must be in the F (out) position. For switching modules, it must be in the R (in) position.

---

To achieve a stable reading, it helps to shield resistances greater than 100 k $\Omega$ . As shown in the figures in [Front-panel inputs](#) (on page 4-17) and [Model 7700 connections for resistance measurements](#) (on page 4-18), place the resistance in a shielded enclosure and connect the shield to the input low terminal of the instrument electrically.

For high resistance measurements in a high humidity environment, use Teflon™ insulated cables to minimize errors due to cable leakage.

### Front-panel inputs

Connections for resistance measurements are shown in the following figure. For 2-wire resistance measurements ( $\Omega 2$ ), connect the test leads to INPUT HI and LO as shown in A,  $\Omega 2$  Connections. For 4-wire resistance ( $\Omega 4$ ), connect the test leads to INPUT HI and LO, and SENSE  $\Omega 4$  HI and LO as shown in B,  $\Omega 4$  Connections.

**Figure 12:  $\Omega 2$  and  $\Omega 4$  connections for front-panel inputs**

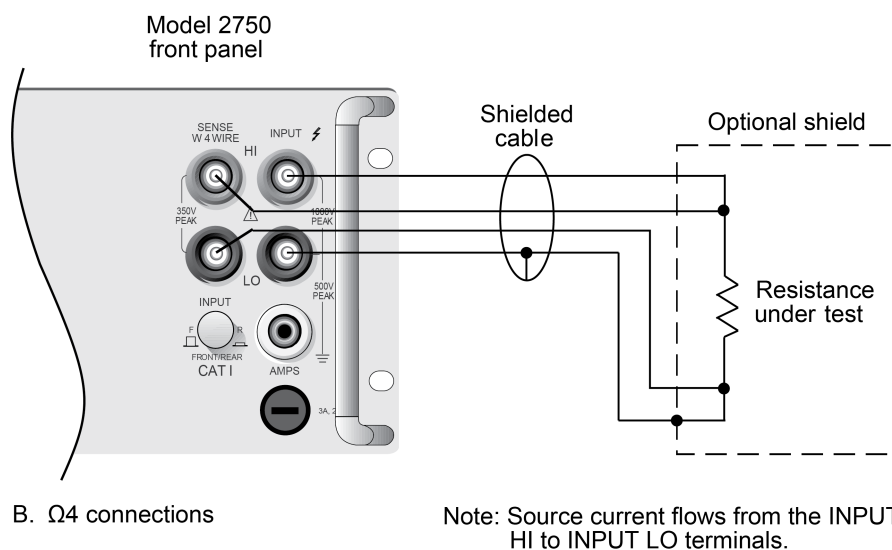
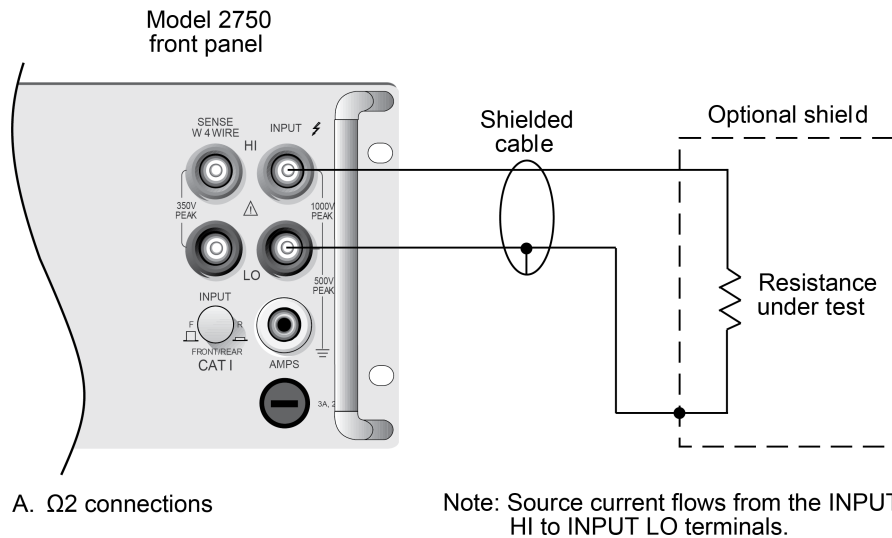

### Model 7700 connections for resistance measurements

Connections for the Model 7700 switching module are shown in the following figure.

As shown in A,  $\Omega 2$  Connections, each of the 20 channels can be used to perform  $\Omega 2$  measurements.

For  $\Omega 4$  measurements, a channel pair is used for each 4-wire measurement, as shown in B,  $\Omega 4$  Connections. Channels 1 through 10 are used as the INPUT terminals and are paired to channels 11 through 20, which are used as the SENSE terminals. Channel 1 is paired to channel 11, channel 2 is paired to channel 12, and so on.

**Figure 13:  $\Omega 2$  and  $\Omega 4$  connections for the Model 7700 switching module**

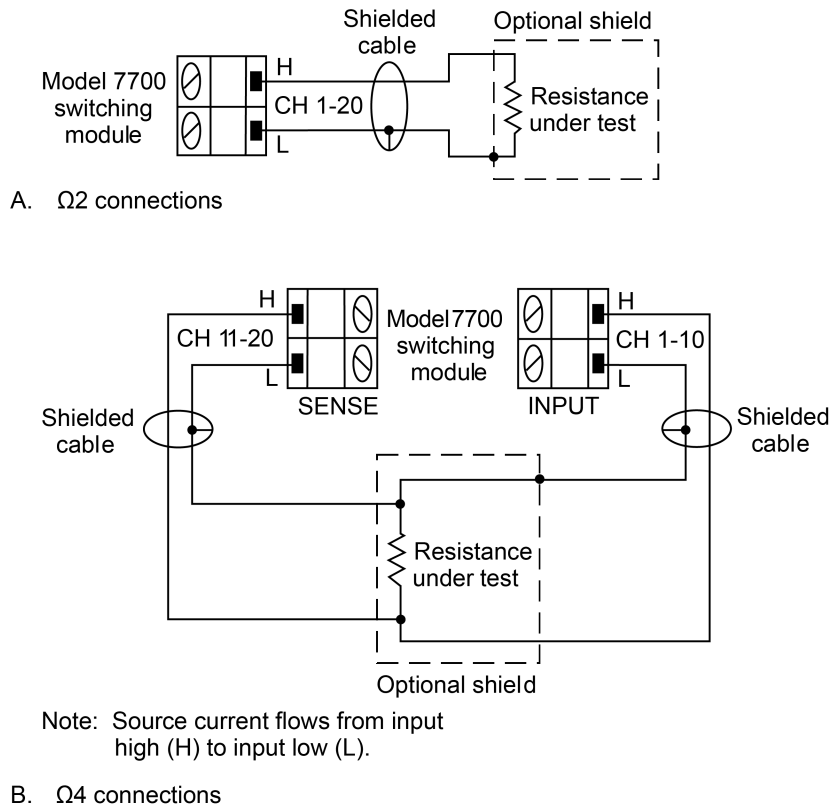

## Standard resistance measurements

### CAUTION

For front-panel inputs, do not apply more than 1000 V<sub>PEAK</sub> between INPUT HI and LO, or instrument damage may occur. For Model 7700 switching modules, do not apply more than 300 VDC or V<sub>RMS</sub> between input high (H) or input low (L), or switching module damage may occur.

#### *To measure resistance:*

1. If a switching channel is closed (displayed), press **OPEN** to open it.
2. Select the ohms measurement function by pressing **Ω2** or **Ω4**.
3. Use the **RANGE ▲** and **▼** keys to select a measurement range consistent with the expected resistance, or press **AUTO** to select autoranging (AUTO annunciator turns on).
4. Connect the resistances to be measured.
5. If using a switching module, press the **CLOSE** key to close the channel. Use **◀**, **▶**, **▲**, and **▼** to key in the channel number and press **ENTER**. The previously closed channels (if any) open, and the specified channel or channel pair closes. For Ω4 measurements, you close the primary (INPUT) channel (1 through 10). The paired channel closes automatically.

### NOTE

In the normal measurement state, you can use the **◀** and **▶** keys to close channels. In general, each key press opens the presently closed channel, and then closes the next higher or lower channel.

6. Observe the displayed reading. If the **OVERFLOW** message is displayed, select a higher range until a normal reading is displayed (or press **AUTO** for autoranging). For manual ranging, use the lowest possible range for the best resolution.
7. To measure other switching channels, repeat steps 5 and 6.
8. When finished, press **OPEN** if there is a channel closed.

## Offset-compensated ohms

The presence of thermal EMFs ( $V_{EMF}$ ) can adversely affect low-resistance measurement accuracy. To overcome these unwanted offset voltages, you can use offset-compensated ohms (OCOMP). Offset-compensated ohms measurements can be performed on the 1  $\Omega$ , 10  $\Omega$ , 100  $\Omega$ , 1 k $\Omega$ , and 10 k $\Omega$  ranges for the  $\Omega 4$  function. It cannot be done on the  $\Omega 2$  function.

---

### NOTE

Instrument operations are performed on the input signal in a sequential manner. The offset-compensated ohms operation is the first operation. Refer to “Signal processing sequence” in the *Model 2750 Reference Manual* for details.

---

For a normal resistance measurement, the Model 2750 sources a known current ( $I$ ) and measures the voltage ( $V$ ). The resistance ( $R$ ) is then calculated ( $R=V/I$ ) and the reading is displayed.

For offset-compensated ohms, two measurements are performed: One normal resistance measurement and one using the lowest current source setting.

The offset-compensated ohms reading is then calculated as follows:

$$\text{Offset-compensated ohms reading} = \Delta V / \Delta I$$

where:

- $\Delta V = V_2 - V_1$
- $\Delta I = I_2 - I_1$
- $V_1$  is the voltage measurement with the current source at its normal level
- $V_2$  is the voltage measurement using the lowest current source setting

This two-point measurement process and reading calculation eliminates the resistance contributed by the presence of  $V_{EMF}$ .

## Performing offset-compensated ohms measurements

Offset-compensated ohms can only be performed on the  $\Omega 4$  function using the 1  $\Omega$ , 10  $\Omega$ , 100  $\Omega$ , 1 k $\Omega$ , or 10 k $\Omega$  range. Make sure you use 4-wire connections to the DUT, as shown in [Connections](#) (on page 4-10).

To enable offset-compensated ohms, press **SHIFT** and then **OCOMP**. When enabled, the **OCOMP** annunciator is on. To disable offset-compensated ohms, press **SHIFT** and then **OCOMP**.

The **OCOMP** annunciator will flash when the instrument is on an invalid range (100 k $\Omega$  through 100 M $\Omega$  ranges) for offset-compensated ohms. Normal ohms measurements will instead be performed.

With dry circuit ohms enabled, 1 k $\Omega$  is the highest offset-compensated ohms range that can be selected.

For buffer recall, there is no way to distinguish between a normal ohms reading and an offset-compensated ohms reading. The **OCOMP** annunciator (off, on, or flashing) has no significance for recalled resistance readings that are displayed.

If the offset-compensated ohms feature is enabled and you change measurement functions, it remains enabled when you return to the  $\Omega 4$  measurement function.

---

## NOTE

Make sure the INPUTS switch is in the correct position. To use front-panel inputs, it must be in the F (out) position. For switching modules, it must be in the R (in) position.

---

### *To perform offset-compensated ohms measurements:*

1. If a switching channel is presently closed (displayed), press **OPEN** to open it.
2. Select the 4-wire ohms measurement function by pressing  $\Omega 4$ .
3. Press **SHIFT** and then **OCOMP**.
4. Use the **RANGE** up and down keys to select the 1  $\Omega$ , 10  $\Omega$ , 100  $\Omega$ , 1 k $\Omega$ , or 10 k $\Omega$  range, or press **AUTO** to enable autorange. If using autorange, offset-compensated ohms measurements will not be performed if the instrument goes to the 100 k $\Omega$  or higher range.
5. Connect the resistances to be measured.



6. If using a switching module, press the **CLOSE** key to close the channel. Use ◀, ▶, ▲, and ▼ to key in the channel number and press **ENTER**. The previously closed channels (if any) open, and the specified channel or channel pair closes. For  $\Omega 4$  measurements, you close the primary (INPUT) channel (1 through 10). The paired channel closes automatically.

---

## NOTE

In the normal measurement state, you can use the ◀ and ▶ keys to close channels. In general, each key press opens the presently closed channel, and then closes the next higher or lower channel.

---

7. Observe the displayed reading. If the **OVERFLOW** message is displayed, select a higher range until a normal reading is displayed (or press **AUTO** for autoranging). For manual ranging, use the lowest possible range for the best resolution.
8. To measure other switching channels, repeat steps 5 and 6.
9. When finished, press **OPEN** if there is a channel closed.

## Dry circuit ohms (DRYCKT)

Standard resistance measurements have open-circuit voltage levels from 5.4 V to 12.8 V, depending on the selected range. The dry circuit ohms feature limits open-circuit voltage to 20 mV. This allows you to perform resistance measurements that require low open-circuit voltage.

Dry circuit ohms can be used on the 1  $\Omega$ , 10  $\Omega$ , 100  $\Omega$ , and 1 k $\Omega$  ranges for the  $\Omega 4$  function only.

Offset-compensated ohms (OCOMP) can be used with dry circuit ohms to cancel the effect of thermal EMFs.

You can use the dry circuit ohms feature to measure contact resistance. The ideal resistance between switch connectors, or relay contacts is 0  $\Omega$ . However, an oxide film may be present on the switch or relay contacts. This oxide film could add resistance of several hundred megaohms. This oxide film also changes the contact resistance over time and with changes in the environmental conditions (such as temperature and humidity).

Typically, the  $\Omega 4$  function of the Model 2750 or a standard DMM is used to measure low resistance. However, if standard resistance measurements are performed, the relatively high open-circuit voltage may puncture the oxide film, and render the test meaningless. Dry circuit ohms limits voltage to 20 mV to minimize any physical and electrical changes in a measured contact junction. This low open-circuit voltage will not puncture the film, and will therefore provide a resistance measurement that includes the resistance of the oxide film.

Oxide films may also build up in connections on a semiconductor wafer. To accurately measure the resistance introduced by the oxide film, dry circuit ohms should be used to prevent oxide film puncture.

You should also use the dry circuit ohms feature to measure devices that could be damaged by high open-circuit voltage. If not sure, and the slightly degraded accuracy is not a consideration, it is good practice to use dry circuit ohms to measure low resistance.

### Performing dry circuit ohms measurements

Dry circuit ohms can only be performed on the  $\Omega 4$  function using the 1  $\Omega$ , 10  $\Omega$ , 100  $\Omega$ , or 1 k $\Omega$  range.

To enable dry circuit ohms, press **SHIFT** and then **DRYCKT**. When enabled, the **DCKT** annunciator is on. When you enable dry circuit ohms, the offset-compensated ohms feature is automatically enabled (**OCOMP** annunciator turns on). If you do not wish to use offset-compensated ohms, press **SHIFT** and then **OCOMP**. To disable dry circuit ohms, press **SHIFT** and then **DRYCKT**.

If offset-compensated ohms or offset-compensated ohms is enabled and you change measurement functions, they remain enabled when you return to the  $\Omega 4$  measurement function.

The accuracy specifications for the dry circuit ohms feature are for offset-compensated ohms and line synchronization enabled.

---

### NOTE

Make sure the **INPUTS** switch is in the correct position. To use front-panel inputs, it must be in the **F** (out) position. For switching modules, it must be in the **R** (in) position.

---

---

### NOTE

Do not make connections to the DUT until after dry circuit ohms is enabled in step 2.

---

#### ***To perform dry circuit ohms measurements:***

1. If a switching channel is presently closed (displayed), press **OPEN** to open it.
2. Select the 4-wire ohms measurement function by pressing  **$\Omega 4$** .
3. Enable dry circuit ohms by pressing **SHIFT** and then selecting **DRYCKT**.
4. Make 4-wire connections to the DUT as shown in [Front-panel inputs](#) (on page 4-17) or [Model 7700 connections for resistance measurements](#) (on page 4-18).
5. Use the **RANGE ▲** and **▼** keys to select the 1  $\Omega$ , 10  $\Omega$ , 100  $\Omega$ , or 1 k $\Omega$  range, or press **AUTO** to enable autorange.

6. Connect the resistances to be measured.
7. If using a switching module, press the **CLOSE** key to close the channel. Use ◀, ▶, ▲, and ▼ to key in the channel number and press **ENTER**. The previously closed channels (if any) open, and the specified channel or channel pair closes. For  $\Omega$ 4 measurements, you close the primary (INPUT) channel (1 through 10). The paired channel closes automatically.

---

## NOTE

In the normal measurement state, you can use the ◀ and ▶ keys to close channels. In general, each key press opens the presently closed channel, and then closes the next higher or lower channel.

---

8. Observe the displayed reading. If the **OVERFLOW** message is displayed, select a higher range until a normal reading is displayed (or press **AUTO** for autoranging). For manual ranging, use the lowest possible range for the best resolution.
9. To measure other switching channels, repeat steps 5 and 6.
10. When finished, press **OPEN** if there is a channel closed.

### Dry circuit ohms measurement considerations

The dry circuit ohms feature uses a constant current source with voltage monitoring that is used to clamp the current source voltage. The current source will remain constant as long as the monitoring voltage is <20 mV. When the voltage exceeds 20 mV, the current source shunts current internal to the DMM until 20 mV is maintained at the DUT.

The voltage is monitored at the Sense HI terminal. This allows the Model 2750 to accommodate an additional 80% of range of path resistance per lead. So, when measuring a 1  $\Omega$  resistor through a switching module, an additional 0.8  $\Omega$  per lead of path resistance can be tolerated. Lead resistance of several 100 m $\Omega$  is common with a switching module, especially when using ribbon cable wire.

There is a secondary voltage monitoring circuit on Input HI. This is needed if Sense HI or Input HI have different voltages. This could occur if measuring 4-wire resistance and Input HI becomes an open circuit. In this condition, Sense HI would indicate no voltage and the secondary voltage monitor would clamp the current source to <50 mV.

When using dry circuit ohms, the DUT is shunted by 100 k $\Omega$  and 0.9  $\mu$ F. This allows the current source to have minimal overshoot voltage under transient conditions. When used with a switching system, the overshoot is <70 mV in 25  $\mu$ s.

## Temperature measurements

The Model 2750 can measure temperature using thermocouples, thermistors, and 4-wire RTDs.

### Thermocouples

For thermocouples, temperature measurement range depends on which type of thermocouple is being used. Thermocouples that are supported include types J, K, N, T, E, R, S, and B.

Type	Range	Resolution
J	-200 °C to 760 °C	0.001 °C
K	-200 °C to 1372 °C	0.001 °C
N	-200 °C to 1300 °C	0.001 °C
T	-200 °C to 400 °C	0.001 °C
E	-200 °C to 1000 °C	0.001 °C
R	0 °C to 1768 °C	0.1 °C
S	0 °C to 1786 °C	0.1 °C
B	+350 °C to 1820 °C	0.1 °C

When two wires made up of dissimilar metals are joined together, a voltage is generated. The generated voltage is a function of temperature. As temperature changes, the voltage changes. The thermocouple voltage equates to a temperature reading. This is the basic operation principle of the thermocouple.

---

## NOTE

The equation to calculate thermocouple temperature is provided in the *Model 2750 Reference Manual*.

---

When you connect a thermocouple directly to the input of the Model 2750, at least one of those connections is a junction made up of two dissimilar metals. This introduces another voltage and is algebraically added to the thermocouple voltage. The result is an erroneous temperature measurement.

To cancel the affects of the unwanted thermal voltage, the thermocouple circuit requires a reference junction that is at a known temperature.

## Reference junctions

A reference junction is the cold junction in a thermocouple circuit which is held at a stable, known temperature. It is at the cold junction where dissimilar wire connections must be made. As long as the temperature of the cold junction is known, the Model 2750 can factor in the reference temperature to calculate the actual temperature reading at the thermocouple.

The standard reference temperature is the ice point (0 °C). The ice point can be precisely controlled, and the National Bureau of Standards uses it as the fundamental reference for its voltage-to-temperature conversion tables. However, other known temperatures can be used.

The Model 2750 can acquire the cold junction temperature by measuring the cold junction using a thermistor or 4-wire RTD or by using a known temperature value entered by the user.

The reference junction types supported by the Model 2750 are simulated reference junction, internal reference junction, and external reference junction. These reference junctions are explained in the following topics.

---

## NOTE

When using multiple channel operation (`ROUT:MULT` command) to connect a switching module input channel to the DMM, the simulated reference junction is used if the internal or external reference junction is selected.

---

### Simulated reference junction

An example of a simulated reference junction is an ice bath, as shown in the following figures.

**Figure 14: Simulated reference junction using front-panel inputs**

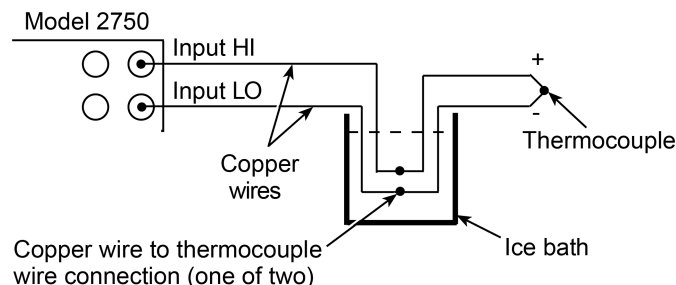

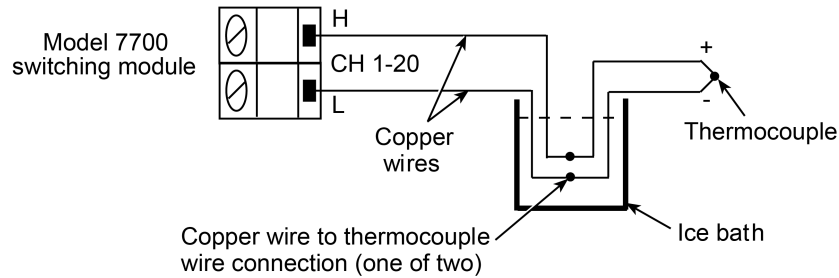
**Figure 15: Simulated reference junction using the Model 7700**

The copper wire to thermocouple wire connections are immersed (but electrically isolated) in the ice bath, and the user enters the 0 °C simulated reference temperature into the Model 2750. The simulated reference temperature for the Model 2750 can be set from 0 to 65 °C.

The Model 2750 measures the input voltage and factors in the simulated reference temperature to calculate the temperature reading at the thermocouple.

---

## NOTE

The most accurate temperature measurements are achieved by using a simulated reference junction using an ice point reference.

---

### Internal reference junction

When internal reference junction is selected, a temperature transducer is used to measure the cold junction. For the Model 7700 switching module, the cold junction is the screw terminals, with voltage temperature sensors strategically placed to measure the temperature of the cold junction.

The Model 2750 measures the temperature of the cold junction, measures the input voltage, and then calculates the temperature reading at the thermocouple.

### External reference junction

For switching modules that do not have built-in sensors to measure temperature, each module can use a thermistor or 4-wire RTD to acquire the reference temperature. Connect a thermistor to channel 1 or connect a 4-wire RTD to channel 1 and its paired channel.

Position the temperature transducer near the terminals for the channels being used to measure temperature. Be sure to electrically insulate the transducer leads to keep them from contacting other conductors.

When you close channel 1 to measure the cold junction temperature, that temperature reading is used to calculate the temperature when you close a thermocouple channel.

## Open thermocouple detection

Long lengths of thermocouple wire can have a large amount of capacitance that is seen at the input of the DMM. If an intermittent open occurs in the thermocouple circuit, the capacitance could cause an erroneous on-scale reading.

The Model 2750 has an open thermocouple detection circuit. When enabled, a 10  $\mu\text{A}$  pulse of current is applied to the thermocouple before the start of each temperature measurement. If more than 12 k $\Omega$  is detected (open thermocouple), the `OVRFLW` message is displayed. If less than 12 k $\Omega$  is detected, the current is turned off and a normal thermocouple temperature measurement is made.

---

### NOTE

Channel average cannot be used with thermocouple temperature measurements if open thermocouple detection is enabled.

---

## Thermistors

For thermistors, the temperature measurement range is  $-80\text{ }^{\circ}\text{C}$  to  $150\text{ }^{\circ}\text{C}$  (0.01  $^{\circ}\text{C}$  resolution). Thermistor types that are supported include the 2.2 k $\Omega$ , 5 k $\Omega$ , and 10 k $\Omega$  types.

The thermistor is a temperature sensitive resistor. Its resistance changes non-linearly with changes in temperature. Most thermistors have a negative temperature coefficient. As temperature increases, the resistance decreases. The Model 2750 measures the resistance of the thermistor and calculates the temperature reading.

Of all the temperature transducers, the thermistor is the most sensitive. It can quickly detect minute changes in temperature. It is a good choice when measuring very small changes in temperature. The downside for this increased sensitivity is the loss of linearity. Since they are especially non-linear at high temperatures, it is best to use them for measurements below 100  $^{\circ}\text{C}$ .

---

### NOTE

Curve fitting constants are used in the equation to calculate thermistor temperature. The thermistor manufacturer's specified curve fitting constants may not be the same as the ones used by the Model 2750. Refer to "Thermistor equation" in the *Model 2750 Reference Manual* for the equation and the constants used by the Model 2750. It also explains how to select a thermistor when the manufacturer's constants and the ones used by the Model 2750 do not match.

---

## 4-wire RTDs

For 4-wire RTDs, the temperature measurement range is  $-200\text{ }^{\circ}\text{C}$  to  $630\text{ }^{\circ}\text{C}$  ( $0.01\text{ }^{\circ}\text{C}$  resolution). RTD types that are supported include D100, F100, PT385, and PT3916. A USER type is available to modify RTD parameters, such as the resistance at  $0\text{ }^{\circ}\text{C}$ . The USER type can be enabled from the front panel, but the settings can only be changed using remote programming.

The RTD has a metal construction (typically platinum). The resistance of the RTD changes with change in temperature. The Model 2750 measures the resistance and calculates the temperature reading. When using default RTD parameters, the resistance of the RTD is  $100\ \Omega$  at  $0\text{ }^{\circ}\text{C}$ .

Of all the temperature transducers, the RTD exhibits the most stability and linearity. The Model 2750 performs the 4-wire measurement using offset-compensated ohms. This provides the most accurate way to measure the low resistance of the RTD.

---

### NOTE

The equation to calculate temperature versus resistance readings listed is in the RTD reference tables provided in the *Model 2750 Reference Manual*.

---

---

### NOTE

There can be only one USER RTD per scan list.

---

## Temperature connections

---

### NOTE

Make sure the INPUTS switch is in the correct position. To use front-panel inputs, it must be in the F (out) position. For switching modules, it must be in the R (in) position.

---



## Thermocouple connections

Thermocouples are color coded to identify the positive (+) and negative (-) leads, as shown in the following table. Note that the negative (-) lead for U.S. type thermocouples is red.

### Color codes of thermocouple wires

Thermocouple type		Positive (+)	Negative (-)	Thermocouple type		Positive (+)	Negative (-)
J	U.S.	White	Red	E	U.S.	Purple	Red
	British	Yellow	Blue		British	Brown	Blue
	DIN	Red	Blue		DIN	Red	Black
	Japanese	Red	White		Japanese	Red	White
	French	Yellow	Black		French	Yellow	Blue
K	U.S.	Yellow	Red	R	U.S.	Black	Red
	British	Brown	Blue		British	White	Blue
	DIN	Red	Green		DIN	Red	White
	Japanese	Red	White		Japanese	Red	White
	French	Yellow	Purple		French	Yellow	Green
N	U.S.	Orange	Red	S	U.S.	Black	Red
	British	—	—		British	White	Blue
	DIN	—	—		DIN	Red	White
	Japanese	—	—		Japanese	Red	White
	French	—	—		French	Yellow	Green
T	U.S.	Blue	Red	B	U.S.	Gray	Red
	British	White	Blue		British	—	—
	DIN	Red	Brown		DIN	Red	Gray
	Japanese	Red	White		Japanese	Red	Gray
	French	Yellow	Blue		French	—	—

For front-panel inputs, you need to use a simulated reference junction for thermocouple temperature measurements. You can also use a simulated reference junction for the Model 7700 switching module. Refer to [Simulated reference junction](#) (on page 4-26) for more detail.

## NOTE

The positive lead of the type T thermocouple is made of copper. Therefore, that lead can be connected directly to the input of the Model 7700. It does not have to be maintained at the simulated reference temperature.

You can also connect the thermocouple wires directly to the screw terminals (internal reference junction) as shown in the following figure. Using a simulated reference junction may be inconvenient but it provides more accurate temperature measurements (assuming the user enters a precise reference temperature).

**Figure 16: Internal reference junction using a Model 7700**

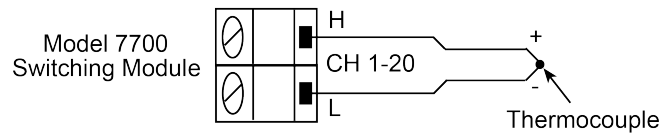

With open thermocouple detection disabled, the Model 2750 can calculate the average temperature of two thermocouple channels using Channel Average. As shown in the following figure, one thermocouple is connected to a primary channel (1 through 10) and the other thermocouple is connected to its paired channel (11 through 20). Channel 1 is paired to channel 11, channel 2 is paired to channel 12, and so on. You can use a simulated reference junction, such as an ice bath, for these thermocouple temperature measurements.

**Figure 17: Channel average calculation, internal reference junction using a Model 7700**



**Thermistor connections**

A thermistor can be connected directly to the front-panel inputs or to any of the 20 input channels of the Model 7700 switching module, as shown in the following figure.

**Figure 18: Thermistor connections**

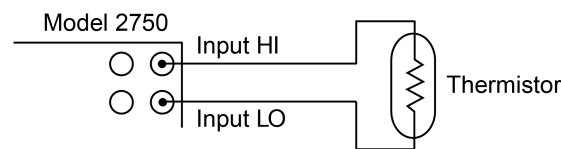

A. Front panel inputs

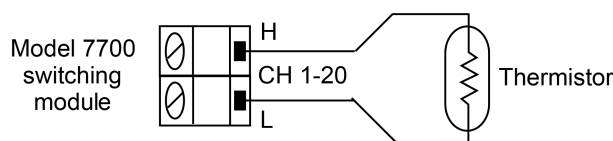

B. Model 7700 switching module

## 4-wire RTD connections

The following figure shows 4-wire RTD connections to the 2750. For the Model 7700 switching module, paired channels are used to perform the 4-wire measurement. The two input leads of the RTD are connected to a primary channel (1 through 10), while the two sense leads are connected to its paired channel (11 through 20). Channel 1 is paired to channel 11, channel 2 is paired to channel 12, and so on.

**Figure 19: 4-wire RTD connections**

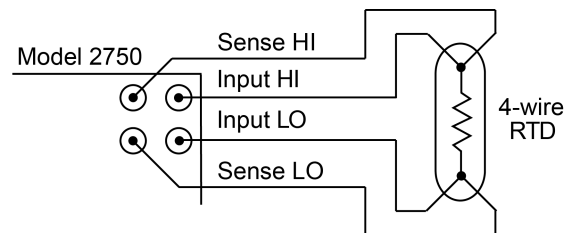

A. Front panel inputs

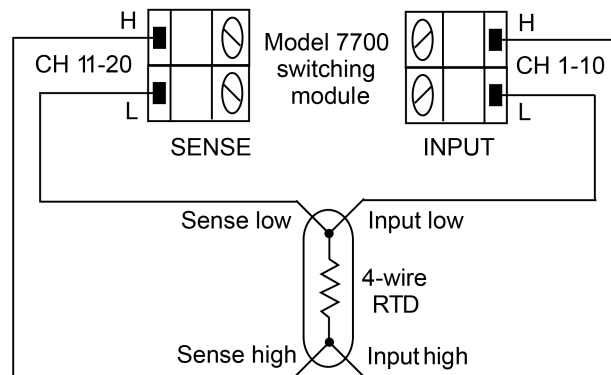

B. Model 7700 switching module

## Temperature measurement configuration

The Model 2750 is configured to measure temperature from the temperature measurement configuration menu. Use the following general rules to navigate through the menu structure:

- Press **SHIFT** and then **SENSOR** to enter the menu structure.
- Cursor position is indicated by a flashing menu item or parameter. Cursor position is controlled by the ◀ and ▶ keys.
- With the cursor on a menu item or parameter, use the ▲ and ▼ keys to scroll through the available options.
- A displayed menu item and parameter is selected by pressing **ENTER**.
- You can exit from the menu structure by pressing **EXIT**. However, any selections that were committed by pressing the **ENTER** key will apply.

## Thermocouple temperature measurement configuration

The steps to configure thermocouple measurements are provided in the following table. After pressing **SHIFT** and then **SENSOR**, the menu starts at step 1 to select measurement units.

Each time you press **ENTER** to make a selection, the menu will automatically go to the next selection. After pressing **ENTER** for the last step, the instrument will return to the normal measurement state.

---

### NOTE

An INT card is a switching module that has an internal reference junction, such as the Model 7700. The INT reference junction setting cannot be selected if there is not at least one INT card installed in the 2750. With no INT cards installed, selecting INT causes the NO INT CARDS message to be displayed briefly.

With at least one INT card installed, you can select the INT reference junction. However, if you select it for the front-panel inputs or for a switching module that does not have an internal reference junction, such as the Model 7702, the simulated (SIM) reference junction is used and the ERR annunciator turns on.

---

## Thermocouple temperature measurement configuration

Step	Menu structure	Description
1	UNITS: C, F, or K	Select temperature measurement units (°C, °F, or K).
2	SENS: TCOUPLE	Select the thermocouple transducer.
3	TYPE: J, K, T, E, R, S, B, or N	Select thermocouple type.
4	JUNC: SIM, INT, or EXT	Select the SIMulated, INTernal, or EXTernal reference junction.*
	SIM: 000 °C to 065 °C, 273 K to 338K, or 032 °F to 149 °F	For the SIMulated reference junction, set the reference junction temperature. The displayed units depend on the present UNITS setting.
5	OPEN DET: Y or N	Enable (Y) or disable (N) the open thermocouple detector.
*When using multiple channel operation (ROUT: MULT command) to connect a switching module input channel to the DMM, the SIMulated reference junction is used if the INTernal or EXTernal reference junction is selected.		

## Thermistor temperature measurement configuration

The steps to configure thermistor measurements are provided in the following table. After pressing **SHIFT** and then **SENSOR**, the menu starts at step 1 to select measurement units.

Each time you press **ENTER** to make a selection, the menu will automatically go to the next selection. After pressing **ENTER** for the last step, the instrument will return to the normal measurement state.

### Thermistor temperature measurement configuration

Step	Menu structure	Description
1	UNITS: C, F, or K	Select temperature measurement units (°C, °F, or K).
2	SENS: THRMSTR	Select the thermistor transducer.
3	TYPE: 2200 Ω, 5000 Ω, or 10 kΩ	Select thermistor resistance.

### 4-wire RTD temperature measurement configuration

The Alpha, Beta, Delta, and  $\Omega$  at 0 °C parameters for the basic RTD types are provided in the following table. Note that these parameters can be modified using remote programming.

#### RTD parameters

Type	Standard	Alpha	Beta	Delta	$\Omega$ at 0 °C
PT100	ITS-90	0.00385055	0.10863	1.49990	100 Ω
D100	ITS-90	0.003920	0.10630	1.49710	100 Ω
F100	ITS-90	0.003900	0.11000	1.49589	100 Ω
PT385	IPTS-68	0.003850	0.11100	1.50700	100 Ω
PT3916	IPTS-68	0.003916	0.11600	1.50594	100 Ω

The steps to configure 4-wire RTD measurements are provided in the following table. After pressing **SHIFT** and then **SENSOR**, the menu starts at step 1 to select measurement units.

Each time you press **ENTER** to make a selection, the menu will automatically go to the next selection. After pressing **ENTER** for the last step, the instrument will return to the normal measurement state.

## NOTE

You can select the USER sensor type, but you cannot change the USER parameters from the front panel. The parameters for the USER type can only be set using remote programming. Refer to the `TEMPERature:FRTD` commands in the *Model 2750 Reference Manual* for details.

### 4-wire RTD temperature measurement configuration

Step	Menu Structure	Description
1	UNITS: C, F, or K	Select temperature measurement units (°C, °F, or K).
2	SENS: 4W-RTD	Select the 4-wire RTD transducer.
3	TYPE: PT100, D100, F100, PT385, PT3916, or USER	Select 4-wire RTD type.

## Temperature measurement procedure

---

### NOTE

Make sure the INPUTS switch is in the correct position. To use front-panel inputs, it must be in the F (out) position. For switching modules, it must be in the R (in) position.

---

#### *To measure temperature:*

1. If a switching channel is presently closed (displayed), press **OPEN** to open it.
2. Select the temperature measurement function by pressing **TEMP**.
3. Configure the temperature measurement as described in [Temperature measurement configuration](#) (on page 4-32).
4. Connect the temperature transducers to be measured.
5. If you are using a switching module, press the **CLOSE** key to close the channel. Use ◀, ▶, ▲, and ▼ to key in the channel number and press **ENTER**.

For 4-wire RTD measurements, you close the primary (INPUT) channel (1 through 10). The channel that it is paired to closes automatically.

The previously closed channels (if any) open and the specified channel or channel pair closes.

---

### NOTE

While in the normal measurement state, you can use the ◀ and ▶ keys to close channels. In general, each key press will open the presently closed channel, and then close the next higher or lower channel.

---

6. Observe the displayed reading.
7. To measure other switching channels, repeat steps 5 and 6.
8. When finished, press **OPEN** if there is a channel closed.

## Frequency and period measurements

The Model 2750 can make frequency measurements from 3 Hz to 500 kHz on voltage ranges of 100 mV, 1 V, 10 V, 100 V, and 750 V. Period (1 / frequency) measurements can be taken from 2  $\mu$ s to 333 ms on the same voltage ranges as the frequency.

Input impedance: 1 M $\Omega$  || <100 pF, AC coupled.

The instrument uses the volts input to measure frequency. The AC voltage range can be changed with the **RANGE**  $\blacktriangle$  and  $\blacktriangledown$  keys. The signal voltage must be greater than 10% of the full-scale range.

---

### CAUTION

The voltage limit is subject to the  $8 \times 10^7$  VHz product.

---

## Trigger level

Frequency and period use a zero-crossing trigger, meaning that a count is taken when the frequency crosses the zero level. The Model 2750 uses a reciprocal counting technique to measure frequency and period. This method generates constant measurement resolution for any input frequency. The AC voltage measurement section of the multimeter performs input signal conditioning.

## Gate time

The gate time is the amount of time the 2750 uses to sample frequency or period readings. Use the RATE key to set the gate time; SLOW sets the gate time to 1.0 s, MED sets it to 0.1 s, and FAST sets it to 0.01 s. For remote programming, the gate time can be set from 0.01 to 1.0 s using the `FREQUENCY:APERTURE` and `PERIOD:APERTURE` commands. Refer to the *Model 2750 Reference Manual* for details on remote programming options. If you set a gate time other than 1.0 s, 0.1 s, or 0.01 s, the SLOW, MED, and FAST annunciators are off.

The 2750 completes a reading when it receives its first zero-crossing after the gate time expires. Therefore, the reading is completed one half cycle after the gate time has expired. For example, to sample a 3 Hz frequency, you may wait up to three seconds before the 2750 returns a reading.

## Frequency and period connections

### Front-panel inputs

When using the front-panel input terminals, connect the test leads to the INPUT HI and LO terminals as shown in the following figure.

**Figure 20: FREQ and PERIOD connections for front-panel inputs**

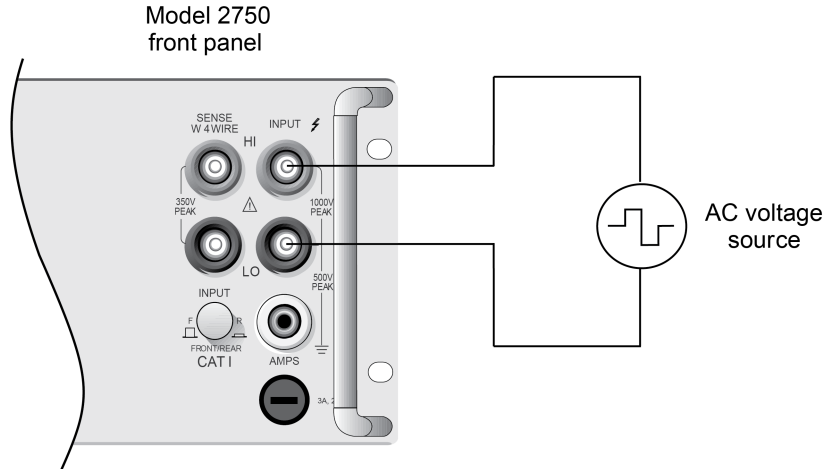

Input impedance = 1 MΩ in parallel with < 100 pF  
 Caution: Maximum input = 1000 V peak,  $8 \times 10^7$  VHz

### Model 7700 connections for frequency and period measurements

Connections for the Model 7700 switching module are shown in the following figure. This is a 2-wire ohms measurement, so channels 1 through 20 can be used.

**Figure 21: FREQ and PERIOD connections using the Model 7700 switching module**

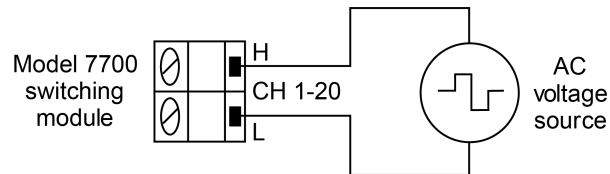

Caution: Maximum = 300 V peak or RMS,  $8 \times 10^7$  VHz



## Frequency and period measurement procedure

---

### NOTE

Make sure the INPUTS switch is in the correct position. To use front-panel inputs, it must be in the F (out) position. For switching modules, it must be in the R (in) position.

---

---

### CAUTION

Do not apply more than maximum input levels indicated in the figures in [Frequency and period connections](#) (on page 4-37) to prevent instrument damage.

---

#### *To measure frequency and period:*

1. If a switching channel is presently closed (displayed), press **OPEN** to open it.
2. Perform one of the following steps to select the function:
  - Press **FREQ** to perform frequency measurements.
  - Press **SHIFT** and then **FREQ** to perform period measurements.
3. Use the **RANGE ▲** and **▼** keys to select a measurement range consistent with the expected AC voltage.
4. Apply the AC voltages to be measured.
5. If you are using a switching module, press the **CLOSE** key to close the channel. Use **◀**, **▶**, **▲**, and **▼** to key in the channel number and press **ENTER**. The previously closed channel opens and the specified channel closes.

---

### NOTE

In the normal measurement state, you can use the **◀** and **▶** keys to close channels. In general, each key press opens the presently closed channel, and then closes the next higher or lower channel.

---

6. Observe the displayed reading. If the **OVERFLOW** message is displayed, select a higher range until a normal reading is displayed. Use the lowest possible range for the best resolution.
7. To measure other switching channels, repeat steps 5 and 6.
8. When finished, press **OPEN** if there is a channel closed.

## Continuity testing

The 2750 can test continuity using the 2-wire 1 kΩ range. After selecting continuity, you are prompted to enter the threshold resistance level (1 Ω to 1000 Ω). When the measured circuit is below the set threshold level, the instrument beeps and displays the resistance readings. When the measured circuit is above the threshold level, the message OPEN is displayed.

The reading rate for continuity is fixed at FAST (0.1 PLC).

---

### NOTE

Limits and digital outputs cannot be used when testing continuity with the continuity (CONT) function. If you need to use these operations, use the Ω2 function to test continuity.

---

## Continuity testing connections

---

### NOTE

Source current flows from input high to input low.

---

## Front-panel inputs

When using the front-panel input terminals, connect the test leads to the INPUT HI and LO terminals as shown in the following figure.

**Figure 22: Continuity connections - front-panel connections**

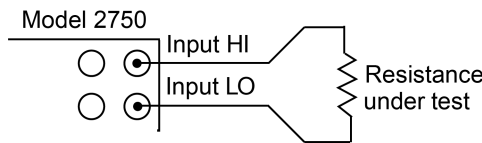

## Model 7700 switching module

Connections for the Model 7700 switching module are shown in the following figure. This is a 2-wire ohms measurement, so channels 1 through 20 can be used.

**Figure 23: Continuity connections - Model 7700**

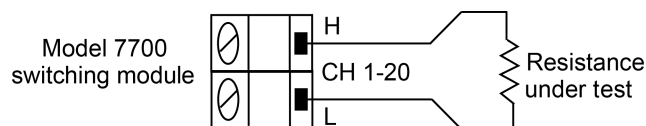

## Continuity testing procedure

### NOTE

Make sure the INPUTS switch is in the correct position. To use front-panel inputs, it must be in the F (out) position. For switching modules, it must be in the R (in) position.

The beeper can be disabled using the `SYSTEM:BEEPER:STATE OFF` command. However, the beeper is automatically enabled the next time the continuity testing function is selected.

Limits and digital outputs cannot be used when testing continuity with the continuity (CONT) function. If you need to use these operations, use the  $\Omega 2$  function to test continuity.

#### *To perform a continuity test:*

1. Apply the resistance to be tested, and, if using a switching module, close the appropriate channel.
2. Press **SHIFT** and then **CONT** to display the present threshold LEVEL.
3. Use **◀**, **▶**, **▲**, and **▼** to key in the level (1  $\Omega$  to 1000  $\Omega$ ), and press **ENTER**.
4. If the measurement is below the threshold level, the beeper sounds and the ohms reading is displayed. If the measurement is above the threshold level, the message OPEN is displayed.
5. To disable continuity testing, select a different function. For example, press **DCV**.

## Range

The range setting is retained by each measurement function. When you select a function, the instrument returns to the last range setting for that function.

## Measurement ranges and maximum readings

The measurement range affects the accuracy of the measurement and the maximum signal that can be measured. The measurement ranges for each function, except frequency, period, and temperature, are listed in the following table.

Function	Ranges	Maximum reading
<b>DCV</b>	100 mV, 1 V, 10 V, 100 V, 1000 V	±1010 V
<b>ACV</b>	100 mV, 1 V, 10 V, 100 V, 750 V	757.5 V
<b>DCI</b>	20 mA, 100 mA, 1 A, 3 A	±3.1 A
<b>ACI</b>	1 A, 3 A	3.1 A
<b>2Ω</b>	10 Ω, 100 Ω, 1 kΩ, 10 kΩ, 100 kΩ, 1 MΩ, 10 MΩ, 100 MΩ	120 MΩ
<b>4Ω*</b>	1 Ω, 10 Ω, 100 Ω, 1 kΩ, 10 kΩ, 100 kΩ, 1 MΩ, 10 MΩ, 100 MΩ	120 MΩ

\* Offset-compensated ohms and dry circuit ohms:  
 OCOMP: Offset-compensated ohms can be performed on the 1 Ω, 10 Ω, 100 Ω, 1 kΩ, and 10 kΩ ranges.  
 DRYCKT: Available ranges for dry circuit ohms include the 1 Ω, 10 Ω, 100 Ω, and 1 kΩ ranges.

**Frequency and period ranges:** Frequency measurements from 3 Hz to 500 kHz and period measurements from 2 μs to 333 μs can be made on the ACV ranges.

**Temperature:** There is no range selection for temperature measurements. Temperature measurements are performed on a single fixed range. Depending on which type of sensor is being used, the maximum temperature readings range from –200 °C to 1820 °C.

Input values that exceed the maximum readings cause the message `OVERFLOW` to be displayed. To resolve this issue, select a higher range until an on-range reading is displayed. Use the lowest range possible without causing an overflow to assure best accuracy and resolution.

The range setting is saved for each measurement function. When you select a function, the instrument returns to the last range setting for that function.

## Relative offset

When making measurements, you may need to subtract an offset value from a measurement.

The relative offset feature subtracts a set value or a baseline reading from measurement readings. When you enable relative offset, all measurements are recorded as the difference between the actual measured value and the relative offset value. The formula to calculate the offset value is:

$$\text{Displayed value} = \text{Actual measured value} - \text{Relative offset value}$$

When a relative offset value is established for a measure function, the value is the same for all ranges for that measure function. For example, if 50 V is set as the relative offset value on the 100 V range, the relative offset value is also 50 V on the 1000 V, 10 V, 1 V, and 100 mV ranges.

When you perform a zero correction by enabling REL, the displayed offset becomes the reference value. Subtracting the offset from the actual input zeroes the display, as follows:

$$\text{Actual Input} - \text{Reference} = \text{Displayed Reading}$$

The relative offset value can be as large as the highest range.

Selecting a range that cannot accommodate the relative offset value does not cause an overflow condition, but it also does not increase the maximum allowable input for that range. For example, on the 10 V range, the Model 2750 still overflows for a 12 V input.

Relative offset is performed on the input signal in a sequential manner. Refer to “Signal processing sequence” in the *Model 2750 Reference Manual* for details.

---

## NOTE

You can perform the equivalent of relative offset manually by using the  $mx+b$  math function. Set  $m$  to 1 and  $b$  to the value of the offset.

---

## Rate

The **RATE** key selects the integration time of the A/D converter. This is the time the input signal is measured and is also known as aperture. The integration time affects the amount of reading noise and the reading rate of the instrument. The integration time is specified in parameters based on the number of power line cycles (PLCs), where 1 PLC for 60 Hz is 16.67 ms (1/60) and 1 PLC for 50 Hz and 400 Hz is 20 ms (1/50).

The shortest amount of time, or lowest NPLC value, results in the fastest reading rate but increases the reading noise and decreases the number of usable digits.

The longest amount of time, or highest NPLC value, provides the lowest reading noise and more usable digits, but has the slowest reading rate.

The 2750 speed versus noise characteristics are shown in the following figure. The 2750 is optimized for the 1 PLC to 5 PLC reading rate. At these speeds, which are shown in the lowest noise region in the graph, the 2750 makes corrections for its own internal drift and is fast enough to settle a step response of less than 100 ms.

**Figure 24: Speed versus noise characteristics**

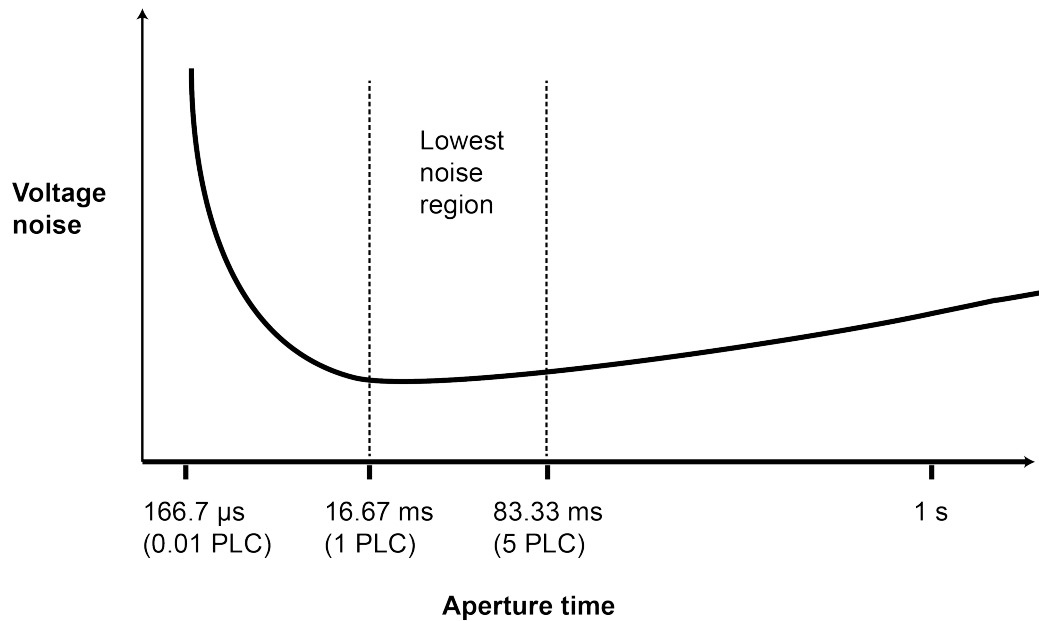

The front-panel **RATE** settings for all but the AC functions are explained as follows:

- **FAST** sets integration time to 0.1 PLC. Use **FAST** if speed is of primary importance (at the expense of increased reading noise and fewer usable digits).
- **MEDium** sets integration time to 1 PLC. Use **MEDium** when a compromise between noise performance and speed is acceptable.
- **SLOW** sets integration time to 5 PLC. **SLOW** provides better noise performance at the expense of speed.

For the AC functions (ACV, ACV dB, and ACI), the **RATE** key sets integration time and bandwidth. As listed in the following table, **FAST** sets NPLC to 1, while the **MEDium** and **SLOW** NPLC settings are ignored.

**Rate and bandwidth settings**

Function	Rate and bandwidth		
	Fast	Medium	Slow
DCV, DCI	NPLC=0.1	NPLC=1	NPLC=5
ACV, ACI	NPLC=1, BW=300	NPLC=X, BW=30	NPLC=X, BW=3
Ω2, Ω4	NPLC=0.1	NPLC=1	NPLC=5
FREQ, PERIOD	APER=0.01 s	APER=0.1 s	APER=1 s
Continuity	NPLC = 0.01	Not available	not available
Notes:			
<ul style="list-style-type: none"> <li>▪ NPLC = number of power line cycles.</li> <li>▪ BW = lower limit of bandwidth (in Hz).</li> <li>▪ APER = aperture in seconds.</li> <li>▪ X = setting ignored.</li> </ul>			

From the front panel, setting the rate for one function affects all the other functions. For example, if you set DCV for medium speed, the other functions are also set to medium speed. For remote programming, each function can have its own rate setting (0.01 to 50 or 60 PLC).

---

## NOTE

Rate cannot be set for continuity. It is fixed at 0.01 PLC.

---

To set the measurement speed from the front panel, the **RATE** key sets the measurement speed. Press **RATE** until the speed annunciator (FAST, MED, or SLOW) turns on.

When a simple scan is configured, the present rate or bandwidth setting applies to all channels in the scan. When an advanced scan is configured, each channel can have its own rate or bandwidth setting. Details to configure and run a scan are provided in Switching and scanning.

When you are using remote programming, you can set integration rate as an aperture. These are the `APERture` commands in the `SENSE[1]` subsystem. Refer to the *Model 2750 Reference Manual* for detail.

---

## NOTE

The Model 2750 uses internal references to calculate an accurate and stable reading. When the NPLC setting is changed, each reference must be updated to the new NPLC setting before a reading is generated. Therefore, frequent NPLC setting changes can result in slower measurement speed.

---

---

## Switch module channel operation

### In this section:

Closing and opening switching module channels.....	5-1
Close/open overview.....	5-1
Channel assignments.....	5-3
System channel operation.....	5-3
Identifying installed modules.....	5-9

## Closing and opening switching module channels

This section includes descriptions of the following:

- **Close/open overview:** Summarizes switching module control.
- **Channel assignments:** Explains the format for specifying the mainframe channel assignment, which is made up of the slot number and switching module channel number.
- **System channel operation:** Provides detailed information for using system channel operation.
- **Identifying installed modules and viewing closed channels:** Explains how to use the CARD menu to identify installed switching modules and view closed channels.

For detailed information on using switching module channels, refer to the *Model 2750 Reference Manual*.

## Close/open overview

---

### NOTE

This section covers basic close and open operations for switching module channels. It also covers the operating characteristics that are unique to the Model 7700 switching module. Unique operating characteristics for all switching modules are provided in the instruction manuals for the individual switching modules.

---



There are two modes of close and open operations:

- **System channel operation:** This is the mode of operation that should be used by most users. When you close an input channel or channel-pair, other channels on the switching module close automatically to internally connect it the DMM of the Model 2750.
- **Multiple channel operation:** This mode of operation provides additional flexibility by providing individual control of each switching module channel. However, careless operation could create a safety hazard and/or damage the switching module and other equipment. Multiple channel operation should only be used by experienced test engineers.

---

## CAUTION

To prevent damage to a switching module, do not exceed the maximum signal level input for that module. Most switching modules are rated for 303 V. The following command queries maximum module voltage:

```
SYSTEM:CARDx:VMAX?  \ Request maximum allowable voltage for
                      \ CARDx (where x is the slot number for
                      \ the module).
```

For system channel operation, the instrument displays the `OVERFLOW` message when the maximum allowable voltage for the module is being exceeded. However, for multiple channel operation, the `OVERFLOW` message does not occur until the maximum voltage of the mainframe (not module) is exceeded. Therefore, the `OVERFLOW` message occurs only if 1010 V is exceeded.

---

## WARNING

Careless multiple channel operation could create an electric shock hazard that could result in severe injury or death. Improper operation can also cause damage to the switching modules and external circuitry. Multiple channel operation should be restricted to experienced test engineers who recognize the dangers associated with multiple channel closures.

---

## NOTE

The Model 2750 can scan switching module channels. Each channel in the scan can have its own setup configuration. Scanning is described in the *Model 2750 Multimeter/Switch System Reference Manual*.

---

## NOTE

When a setup is saved as a user setup (SAV0, SAV1, or SAV2), closed channels are also saved. When the setup is restored, those channels (and only those channels) are closed. Refer to [Defaults and user setups](#) (on page 2-6) for details.

## Channel assignments

The Model 2750 has five slots for switching modules. To control the appropriate switching module, the slot number must be included with the switching module channel number when you specify a channel. The channel assignment is formatted as follows:

*SCH*

where:

- S is the slot number
- CH is the channel number

For example:

- 101 = Slot 1, Channel 1
- 210 = Slot 2, Channel 10
- 506 = Slot 5, Channel 6

## System channel operation

The system channel is a closed measurement channel that is internally connected to the internal DMM input of the 2750. The system channel number is displayed on the 2750. For a 4-wire function, such as  $\Omega 4$ , the paired channel for the system channel is internally connected to DMM sense. The paired channel is not displayed on the 2750. When triggered, the DMM performs a measurement and displays it on the 2750.

The system channel is selected by closing a measurement channel using the system channel close keys. These include the 3 and 4 keys, or the CLOSE key (SINGLE menu option). Refer to [Controlling the system channel](#) (on page 5-6) for details.

Other important points about system channel operation include the following:

- There can only be one system channel. This is the channel that is presently displayed (and closed) on the Model 2750. When a channel is not displayed, there is no system channel.
- When a measurement channel is closed, the input backplane isolation channel also closes to connect the system channel to DMM input. For a 4-wire function, the paired channel and the sense backplane isolation channel also close to make the sense connections to the DMM.
- When a different measurement channel is closed, the previous system channel opens. The newly closed (and displayed) measurement channel becomes the system channel.

- The system channel close keys can only close measurement channels that will automatically connect to the DMM. Non-measurement channels cannot be closed by the system channel close keys.

## NOTE

Use the VIEW option of the CARD menu to display all closed channels in the mainframe. Refer to [CARD menu](#) (on page 5-10) for details.

## 2-wire functions

The following figure shows an example of how the system channel is connected to the DMM Input of the Model 2750. Assume a Model 7700 switching module is installed in slot 1 of the mainframe. When channel 101 is closed using the system channel close keys, both the Channel 1 relay and the backplane isolation relay (Channel 25) closes to connect the channel to the DMM. For the switching modules, switching schematics are provided in the documentation for the switching module, available at [tek.com/keithley](http://tek.com/keithley).

**Figure 25: 2-wire system channel connections to Model 2750 DMM**

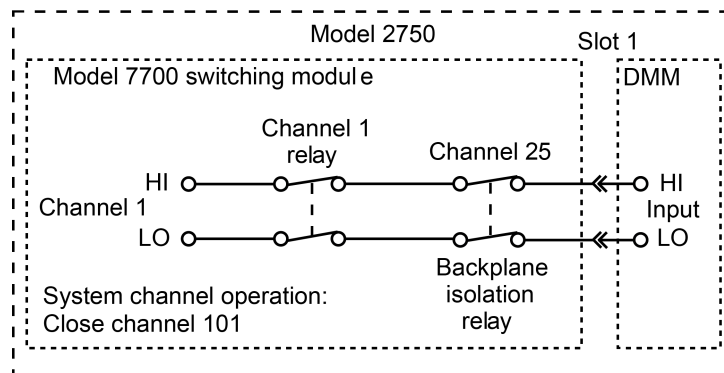

### 4-wire functions (paired channels)

A 4-wire function, such as  $\Omega 4$ , requires that another measurement channel be paired to the system channel. For example, if the switching module has 20 measurement channels, channels 1 through 10 can be used as the system channel, while channels 11 through 20 are used as the paired channel. For a switching module that has 20 measurement channels, channel 1 is paired to channel 11, channel 2 is paired to channel 12, channel 3 is paired to channel 13, and so on.

The following figure shows an example of system channel connections for a 4-wire function. Assume a Model 7700 switching module is installed in slot 1 of the mainframe, and a 4-wire function is selected. When channel 101 is closed using the system channel close keys, the Channel 1 relay and the input backplane isolation relay (Channel 25) close to connect the channel to DMM Input. Also, the Channel 11 relay and the sense backplane isolation relay (Channel 24) closes to connect the paired channel to DMM Sense. Also note in the following figure that the Channel 23 relay closes to isolate channel 1 from channel 11.

**Figure 26: 4-wire system channel connections to the Model 2750 DMM**

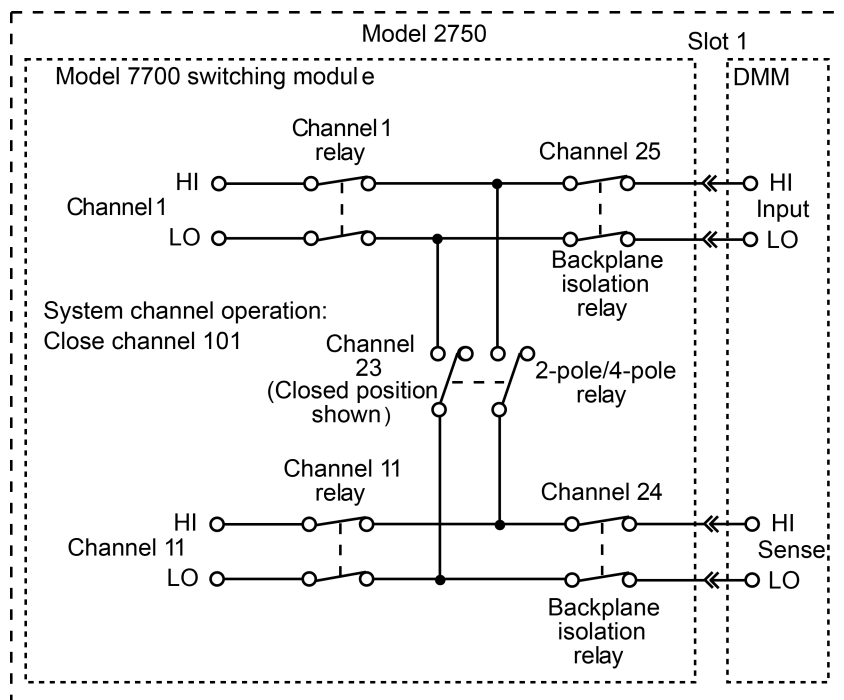

For the switching modules, switching schematics are provided in the documentation for the switching module, available at [tek.com/keithley](http://tek.com/keithley).

## Controlling the system channel

When a measurement channel is closed, a previous system channel (and, for a 4-wire function, its paired channel) is first opened. The closed measurement channel becomes the system channel. When a 4-wire function is selected, the paired channel for the system channel also closes.

### ◀ and ▶ keys

These front-panel keys, shown in the following figure, can be used to select the next or previous measurement channel as the system channel. If there are no measurement channels available, one of the following messages is briefly displayed when one of these keys is pressed:

- NO SCAN CARD: This message indicates that there are no switching modules (or pseudocards) installed. All five slots are empty.
- NO MEAS CARD: This message indicates that none of the installed switching modules (or pseudocards) have measurement channels. For example, the Model 7705 switching module does not have any measurement channels. Those channels cannot be internally connected to the DMM.

You can also use the ◀ and ▶ keys to open all channels in the mainframe. Increment or decrement the channel number until there is no channel displayed.

**Figure 27: System channel operation: Closing next or previous measurement channel**

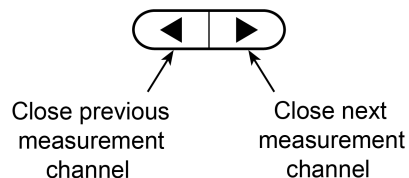

## CLOSE key (SINGLE menu option)

The SINGLE menu option for the **CLOSE** key can be used to select a measurement channel as the system channel, as shown in the following figure.

**Figure 28: System channel operation: Specifying the measurement channel to close**

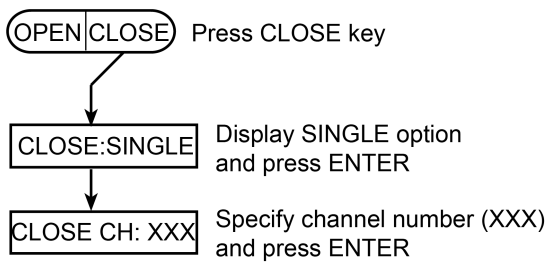

### To select the system channel:

1. Press the **CLOSE** key. The message `CLOSE : SINGLE` message is displayed.

---

## NOTE

If the `CLOSE : MULTI` message is displayed when **CLOSE** is pressed, it indicates that there are no measurement modules installed in the mainframe. Refer to “Multiple channel operation” in the *2750 Reference Manual* to close the channels of a non-measurement module, such as the Model 7705.

2. Press **ENTER** to display the prompt to close a channel (`CLOSE CH: XXX`).
3. Using **▲**, **▼**, **◀**, and **▶**, key in the three-digit channel you want to select.
4. Press **ENTER**. The channel closes and the `CHAN` annunciator turns on.

You cannot close an invalid channel closed. Attempting to close an invalid channel causes one of the following error messages to be briefly displayed: `INVALID CHAN` or `TOO SMALL` or `TOO LARGE`.

INVALID CHAN indicates that the channel is not a valid measurement channel. The following actions cause this error:

- Trying to close a non-measurement channel, such as a backplane isolation channel, a channel that sets the pole mode, or a channel that cannot be internally connected to the DMM.
- Trying to close an amps channel while on a non-amps function. The DCI or ACI function must be selected to close an amps channel.
- Trying to close a paired-channel while on a 4-wire function. For the Model 7700, channels 1 through 10 are paired to channels 11 through 20 for a 4-wire function. If, for example, you try to close channel 12 while on the  $\Omega 4$  function, the INVALID CHAN error will occur.
- Trying to close a switching module channel that does not exist.

TOO SMALL or TOO LARGE indicate an invalid channel. TOO SMALL indicates that the specified channel and any other lower numbered channel is invalid. TOO LARGE indicates that the specified channel and any other higher numbered channel is invalid.

## OPEN key (ALL menu option)

The ALL menu option of the **OPEN** key opens all channels for all switching modules installed in the Model 2750. For example, if a Model 7700 switching module is installed in slot 1, OPEN: ALL will open all measurement channels (101 to 120, 121, and 122), the backplane isolation channels (124 and 125), and the 2-pole/4-pole channel (123).

### To open all channels:

1. Press the **OPEN** key to display OPEN: ALL.
2. Press **OPEN** a second time (or press **ENTER**) to open all channels.

**Figure 29: System channel operation: Opening all channels**

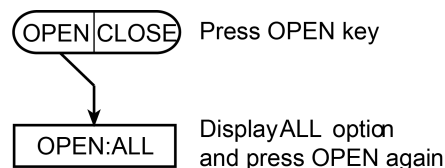

## NOTE

Opening the system channel disables Ratio or Channel Average. Ratio and Channel Average operation is described in the *Model 2750 Reference Manual*.

## Non-amp and non-measure switching modules

There are Keithley switching modules that do not support current measurements and there are modules that do not support any measurements.

For switching modules that do not support current measurements, when an amps function is selected (DCI or ACI), you cannot use system channel operation to close channels on that module. Non-amp Keithley modules include the Models 7701, 7703, 7706, 7707, 7708, and 7709. For information the modules, refer to [tek.com/keithley](https://www.tek.com/keithley).

For modules that do not support any measurements, for front-panel operation, system channel operation cannot be used to close channels. For remote programming, system channel operation can be used, but only the one specified channel closes. All other channels on the module open.

Refer to the *Model 2750 Reference Manual* and the documentation for the switching module for details.

## Identifying installed modules

On power-up, the model numbers of installed switching modules are displayed briefly. While in the normal display state, red slot indicators on the right side of the display indicate which slots have a switching module or pseudocard installed.

---

### NOTE

If a Model 7700, 7701, 7702, 7703, 7705, 7708, or 7709 switching module is removed while the Model 2750 is on, the slot indicator for that slot remains on and the instrument operates as if the module is installed. If a Model 7706 or 7707 is removed while power is on, error +523 ("Card hardware error") occurs, and the module is removed from the system.

In general, it is not recommended to install or remove switching modules with the power on.

---



## CARD menu

The CARD menu identifies the switching modules installed in the mainframe. You can use this menu for the following operations:

- Configure digital inputs and outputs, and analog outputs for switching modules that have one or more of those capabilities, such as the Models 7706 and 7707.
- View the analog input channels that are presently closed. Also, read digital input and output ports, and analog output values for switching modules that have one or more of those capabilities.

Once in the menu structure, the manual range keys (**▲** and **▼**) and the cursor keys (**◀** and **▶**) display menu items and options and set parameter values. When the item, option, or setting is displayed, press the **ENTER** key to select it. You can cancel a pending selection and exit the menu structure by pressing the **EXIT** key.

### *To identify installed modules and pseudocards:*

1. Press the **SHIFT** key and then the **CARD** key to display the **CARD** menu.
2. Select **CONFIG** or **VIEW** and use the **▲** or **▼** key to check each slot. While in the menu structure, the slot indicator for the selected slot is on. The other indicators are off.
3. When finished, press **EXIT**.

The Card menu tree is shown in the following figure.

**Figure 30: CARD menu tree**

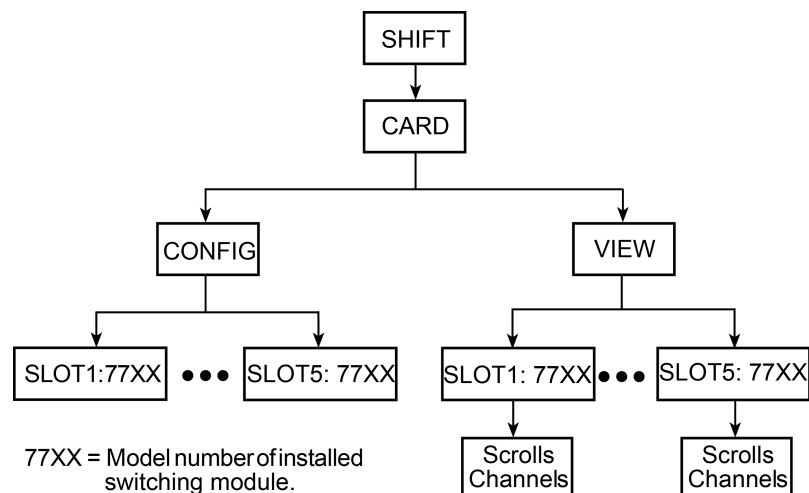

The items and options of the menu are defined in the following list.

**CARD: CONFIG:** This menu item is used to configure switching modules. The channels of the Model 7700 switching module and other similar type modules do not need to be configured.

**SLOTX: 77xx:** Use to configure the switching module in Slot X (where X = 1, 2, 3, 4, or 5). If configuration is not necessary, the instrument will exit from the menu when ENTER is pressed.

---

## NOTE

For switching modules that require configuration, refer to the documentation for the module.

**CARD: VIEW:** This menu item is used to view all analog input channels that are presently closed. These include both measurement and non-measurement channels.

The channels are built into a string that scrolls the display. Four dots identify the end of the string. For example, if the Model 7700 is installed in slot 1, the  $\Omega 4$  function is selected, and system channel 101 is closed, the following string scrolls across the display:

```
101, 111, 123, 124, 125 . . . .
```

Channels 101 and 111 are the paired channels for the 4-wire measurement. Channel 123 is the 4-pole relay setting, and channels 124 and 125 connect input and sense to the DMM of the Model 2750.

---

## NOTE

Some switching modules have analog outputs, digital inputs, and digital outputs. The values for these channels are also displayed from the VIEW menu item. For details on a switching module, refer to the documentation for the module.

**SLOTX: 77xx:** Use to scroll the closed channels and channel settings (if applicable) for the switching module in slot X (where X = 1, 2, 3, 4, or 5).

**Scrolling speed:** The scrolling speed of the channel string is adjustable or can be paused. The ◀ key slows down scrolling speed and the ▶ key speeds it up. The ENTER key pauses scrolling. Press ENTER a second time to resume scrolling.

**Exiting VIEW:** To exit from VIEW, press the EXIT key. Pressing an instrument setting key also exits VIEW, but it also performs the operation associated with the key. For example, pressing  $\Omega 2$  exits VIEW and selects the  $\Omega 2$  function.

---

## NOTE

When a command is received while the display is scrolling, the instrument exits from the CARD menu and the command is executed.

**In this section:**

Introduction .....	6-1
Finding the serial number of the instrument .....	6-1
AMPS fuse replacement (front-panel AMPS input) .....	6-2
Setting line voltage and replacing fuse.....	6-3

## Introduction

This section describes routine maintenance of the instrument that an operator can perform.

## Finding the serial number of the instrument

The instrument serial number is on a label on the rear panel of the instrument. You can also access the serial number from the front panel and by using the command \*IDN? over a remote interface.

***To display the serial number on the front panel:***

1. Press the **SHIFT** key, then select the **SETUP** key to display the SETUP menu.
2. Select **SNUM**. The serial number is displayed.

---

### NOTE

For remote interface information, refer to the *Model 2750 Reference Manual*.

---

## AMPS fuse replacement (front-panel AMPS input)

### WARNING

Make sure the instrument is disconnected from the power line and other equipment before checking or replacing the AMPS fuse. Failure to disconnect all power may expose you to hazardous voltages, that, if contacted, could cause personal injury or death.

### CAUTION

For continued protection against fire or instrument damage, only replace fuse with the type and rating listed. If the instrument repeatedly damages fuses, locate and correct the cause of the problem before replacing the fuse.

#### *To replace a current-input fuse:*

1. Turn off the power to the instrument.
2. Disconnect the power line and test leads.
3. From the front panel, gently push in the AMPS fuse holder with a flat-bladed screwdriver and rotate the fuse holder one-quarter turn counterclockwise.
4. Remove the fuse.
5. Replace the fuse with the same type, as shown in the following table.
6. Install the new fuse by reversing the procedure above.

Manufacturer and part number	Rating
Littelfuse 0235003.HXP	250 V, 3.15 A, fast blow 5 × 20 mm

### NOTE

For the Model 7700 switching module and other similar modules that support the amps function, there are solder mount amps fuses. Refer to the *Model 2750 Service Manual* for amps fuse replacement information.

## Setting line voltage and replacing fuse

A fuse on the 2750 rear panel protects the power-line input of the instrument. The following instructions describe how to replace the fuse. You do not need to return your instrument for service if the fuse is damaged.

---

### **WARNING**

**Disconnect the line cord at the rear panel and remove all test leads connected to the instrument before replacing a line fuse. Failure to do so could expose the operator to hazardous voltages that could result in personal injury or death.**

---

---

### **CAUTION**

**For continued protection against fire or instrument damage, only replace fuse with the type and rating listed. If the instrument repeatedly damages fuses, locate and correct the cause of the problem before replacing the fuse.**

---

#### ***To replace the line fuse:***

1. Power off the instrument and remove the line cord.
2. Place the tip of a flat-blade screwdriver into the power module by the fuse holder assembly. Refer to the figure in [Turning the instrument on and off](#) (on page 2-3).
3. Gently push in and up. Release pressure on the assembly and its internal spring pushes the assembly out of the power module.
4. Remove the fuse and replace it with the type listed in the following table.
5. If you are configuring the instrument for a different line voltage, remove the line voltage selector from the assembly and rotate it to the proper position. When the selector is installed into the fuse holder assembly, the correct line voltage appears sideways in the window.
6. Install the fuse holder assembly into the power module by pushing it in until it locks in place.

If a fuse continues to become damaged, a circuit malfunction exists and must be corrected. Return the instrument to Keithley Instruments for repair.

**Line fuse**

<b>Line voltage</b>	<b>Rating</b>	<b>Manufacturer part number</b>	<b>Keithley part number</b>
100 V/120 V	0.630 A, 250 V, slow-blow 5 mm x 20 mm	Littelfuse 218.630HXP	FU-106-.630
220 V/240 V	0.315A, 250 V, slow-blow 5 mm x 20 mm	Littelfuse 0218.315MXP	FU-106-.315

---

## Status and error messages

### In this section:

Status and error messages ..... 7-1

## Status and error messages

---

### NOTE

SCPI-confirmed messages are described in "Volume 2: Command Reference" of the *Standard Commands for Programmable Instruments (SCPI)*., available at <https://www.ivifoundation.org/docs/scpi-99.pdf>. Refer to the `SYSTem:ERRor?` command description in the *Model 2750 Reference Manual*.

---

Number	Description	Event
-440	Query unterminated after indefinite response	EE
-430	Query deadlocked	EE
-420	Query unterminated	EE
-410	Query interrupted	EE
-363	Input buffer overrun	SYS
-350	Queue overflow	SYS
-330	Self-test failed	EE
-314	Save/recall memory lost	EE
-315	Configuration memory lost	EE
-285	Program syntax error	EE
-284	Program currently running	EE
-282	Illegal program name	EE
-281	Cannot create program	EE
-260	Expression error	EE
-241	Hardware missing	EE
-230	Data corrupt or stale	EE
-225	Out of memory	EE
-224	Illegal parameter value	EE
-223	Too much data	EE
-222	Parameter data out of range	EE
-221	Settings conflict	EE
-220	Parameter error	EE
-215	Arm deadlock	EE
-214	Trigger deadlock	EE
-213	Init ignored	EE
-212	Arm ignored	EE

Number	Description	Event
-211	Trigger ignored	EE
-210	Trigger error	EE
-202	Settings lost due to rtl	EE
-201	Invalid while in local	EE
-200	Execution error	EE
-178	Expression data not allowed	EE
-171	Invalid expression	EE
-170	Expression error	EE
-168	Block data not allowed	EE
-161	Invalid block data	EE
-160	Block data error	EE
-158	String data not allowed	EE
-154	String too long	EE
-151	Invalid string data	EE
-150	String data error	EE
-148	Character data not allowed	EE
-144	Character data too long	EE
-141	Invalid character data	EE
-140	Character data error	EE
-128	Numeric data not allowed	EE
-124	Too many digits	EE
-123	Exponent too large	EE
-121	Invalid character in number	EE
-120	Numeric data error	EE
-114	Header suffix out of range	EE
-113	Undefined header	EE
-112	Program mnemonic too long	EE
-111	Header separator error	EE
-110	Command header error	EE
-109	Missing parameter	EE
-108	Parameter not allowed	EE
-105	GET not allowed	EE
-104	Data type error	EE
-103	Invalid separator	EE
-102	Syntax error	EE
-101	Invalid character	EE
-100	Command error	EE
+000	No error	SE
+101	Operation complete	SE
+121	Device calibrating	SE
+122	Device settling	SE
+123	Device ranging	SE
+124	Device sweeping	SE
+125	Device measuring	SE
+126	Device calculating	SE
+161	Program running	SE
+171	Waiting in trigger layer	SE
+174	Re-entering the idle layer	SE
+180	Filter settled	SE
+301	Reading overflow	SE
+302	Low limit 1 event	SE
+303	High limit 1 event	SE
+304	Low limit 2 event	SE



Number	Description	Event
+305	High limit 2 event	SE
+306	Reading available	SE
+307	Buffer user-selectable event	SE
+308	Buffer available	SE
+309	Buffer half full	SE
+310	Buffer full	SE
+311	Buffer overflow	SE
+312	Buffer one quarter full	SE
+313	Buffer three quarters full	SE
+314	Master limit event	SE
	Calibration messages:	
+400	10vdc zero error	EE
+401	100vdc zero error	EE
+402	10vdc full scale error	EE
+403	-10vdc full scale error	EE
+404	100vdc full scale error	EE
+405	-100vdc full scale error	EE
+406	1k 2-w zero error	EE
+407	10k 2-w zero error	EE
+408	100k 2-w zero error	EE
+409	10M 2-w zero error	EE
+410	10M 2-w full scale error	EE
+411	10M 2-w open error	EE
+412	1k 4-w zero error	EE
+413	10k 4-w zero error	EE
+414	100k 4-w zero error	EE
+415	10M 4-w sense lo zero error	EE
+416	1k 4-w full scale error	EE
+417	10k 4-w full scale error	EE
+418	100k 4-w full scale error	EE
+419	1M 4-w full scale error	EE
+420	10M 4-w full scale error	EE
+421	10m adc zero error	EE
+422	100m adc zero error	EE
+423	10m adc full scale error	EE
+424	100m adc full scale error	EE
+425	1 adc full scale error	EE
+426	10 4-w zero error	EE
+427	1k 4-w zero error	EE
+428	10 2-w zero error	EE
+429	10k 4-w zero error	EE
+430	10k 4-w ocomp lon full scale	EE
+438	Date of calibration not set	EE
+439	Next date of calibration not set	EE
+450	100m vac dac error	EE
+451	1 vac dac error	EE
+452	10 vac dac error	EE
+453	100 vac dac error	EE
+454	100m vac zero error	EE
+455	100m vac full scale error	EE
+456	1 vac zero error	EE
+457	1 vac full scale error	EE
+458	1 vac noise error	EE
+459	10 vac zero error	EE

Number	Description	Event
+460	10 vac full scale error	EE
+461	10 vac noise error	EE
+462	100 vac zero error	EE
+463	100 vac full scale error	EE
+464	750 vac zero error	EE
+465	750 vac full scale error	EE
+466	750 vac noise error	EE
+467	Post filter offset error	EE
+468	1 aac zero error	EE
+469	1 aac full scale error	EE
+470	3 aac zero error	EE
+471	3 aac full scale error	EE
+472	Input time constant error	EE
+473	Frequency gain error	EE
+474	1K Ohm loff Ocomp FS error	EE
+475	10K Ohm loff Ocomp FS error	EE
+476	Temperature Cold Cal error	EE
+477	Analog output zero error	EE
+478	Analog output pos. gain error	EE
+479	Analog output neg. gain error	EE
+480	1k 4-w dckt loff zero error	EE
+481	1k 4-w dckt lon zero error	EE
+482	1k 4-w dckt loff full scale	EE
+483	1k 4-w dckt lon full scale error	EE
+484	100 4-w dckt loff zero error	EE
+485	100 4-w dckt lon zero error	EE
+486	100 4-w ocomp lon zero error	EE
+487	100 4-w ocomp lon full scale	EE
+488	100 4-w dckt loff full scale	EE
+489	100 4-w dckt lon full scale	EE
+490	10 4-w dckt loff zero error	EE
+491	10 4-w dckt lon zero error	EE
+492	10 4-w dckt full scale error	EE
+493	10 4-w full scale error	EE
+494	10 4-w ocomp lon zero error	EE
+495	10 4-w ocomp lon full scale	EE
+496	1 4-w dckt loff zero error	EE
+497	1 4-w dckt lon zero error	EE
+498	1 4-w dckt lon full scale error	EE
+500	Calibration data invalid	EE
+510	Reading buffer data lost	EE
+511	GPIB address lost	EE
+512	Power-on state lost	EE
+513	AC calibration data lost	EE
+514	DC calibration data lost	EE
+515	Calibration dates lost	EE
+516	Battery backed RAM error	EE
+517	Cannot resume scan	EE
+518	Card calibration data lost	EE
+519	Card calibration dates lost	EE
+520	Saved setup scancard mismatch	EE
+521	Card relay counts lost	EE
+522	GPIB communication language lost	EE
+523	Card hardware error	EE

<b>Number</b>	<b>Description</b>	<b>Event</b>
+524	Unsupported card detected	EE
+525	Scancard memory pattern mismatch	EE
+610	Questionable calibration	SE
+611	Questionable temperature	SE
+700	Invalid function in scanlist	EE
+800	RS-232 Framing error detected	EE
+802	RS-232 Overrun detected	EE
+803	RS-232 Break detected	EE
+805	Invalid system communication	EE
+808	ASCII only with RS-232	EE
+900	Internal system error	EE

**In this section:**

[Additional 2750 information.....](#) 8-1

## **Additional 2750 information**

For additional information about the 2750, refer to [tek.com/keithley](http://tek.com/keithley), which contains the most up-to-date information. From the website, you can access:

- The *Model 2750 Reference Manual*, which contains detailed instrument information, including descriptions of the SCPI commands.
- The *Switching Handbook*
- Application notes
- Updated drivers
- Information about related products, including the plug-in modules

In addition, your local Field Applications Engineer can help you with product selection, configuration, and usage. Check the website for contact information.

Specifications are subject to change without notice.  
All Keithley trademarks and trade names are the property of Keithley Instruments.  
All other trademarks and trade names are the property of their respective companies.

---

Keithley Instruments • 28775 Aurora Road • Cleveland, Ohio 44139 • 1-800-833-9200 • [tek.com/keithley](http://tek.com/keithley)

